

# FLOOR FOR THE HOME 2022 COLLECTION

TILES & PLANKS COLLECTION



**Gerflor**



TABLE OF CONTENTS

GERLOR GROUP ..... P4  
 GERFLOR DECORATION TRENDS 2022 ..... P10  
 MAKE THE RIGHT CHOICE ..... P14  
 SENSO RANGE ..... P15

LVT INTERLOCKING

SENSO PREMIUM CLIC ..... P16  
 SENSO CLIC..... P26  
 SENSO 20 LOCK..... P34

LVT LOOSELAY

SENSO EASY PREMIUM ..... P40

LVT SELF ADHESIVE

SENSO SA PREMIUM..... P46  
 SENSO SELF-ADHESIVE ..... P52  
 VINYL TILES..... P62

CLEANING - NUMERICAL INDEX  
 COMMUNICATION TOOLS

CLEANING INSTRUCTIONS ..... P65  
 NUMERICAL INDEX..... P66  
 COMMUNICATION TOOLS..... P67

# GERFLOR GROUP

## continually moving forward

**To create**, manufacture & market innovative, design-led & eco-responsible solutions for flooring, walls & their finishes.

**To anticipate** the specific needs of the users, specifiers, installers & distributors around the world.

**To provide** competitiveness & success for all our customers.

### INTERNATIONAL PRESENCE

& PROXIMITY TO OUR CUSTOMERS THROUGH:

- ✓ 28 subsidiaries & a broad network of distributor partners.
- ✓ 17 production plants & logistic hubs.
- ✓ STAFF: 4 000 employees, 40 nationalities.

Sales growth  
Gerflor group turnover

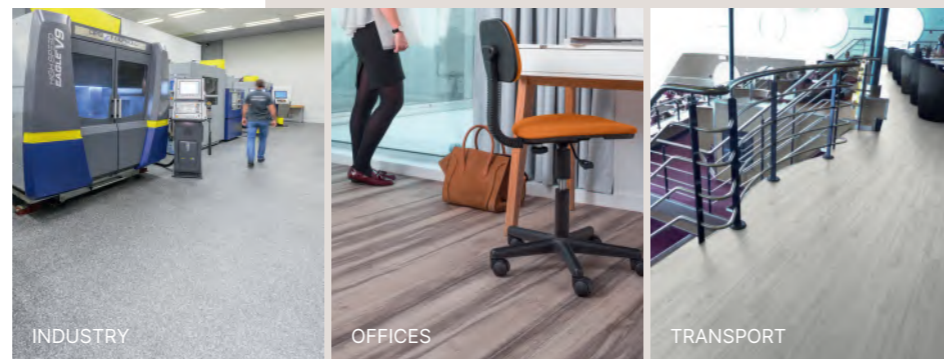
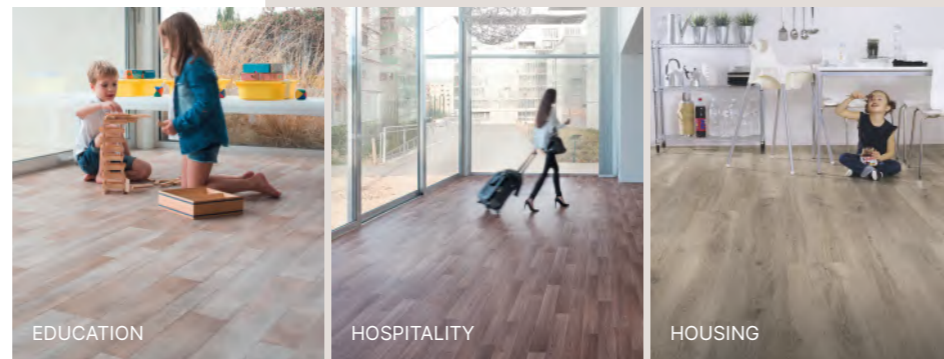
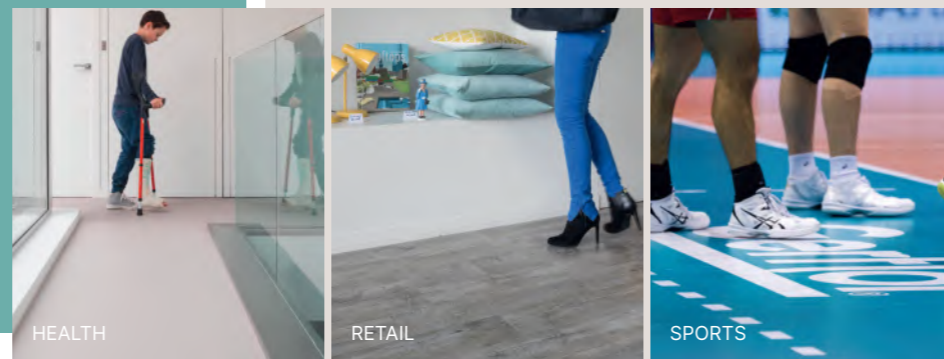
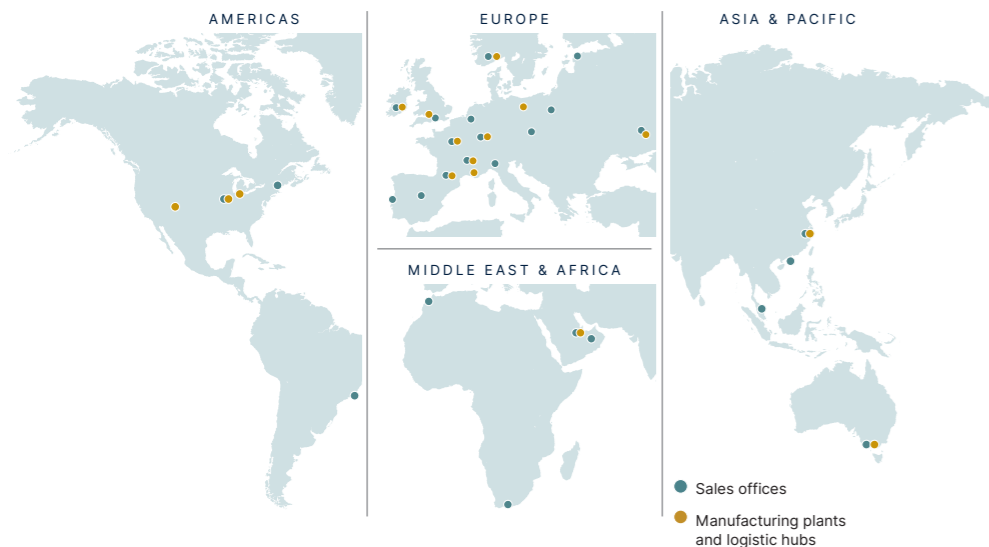
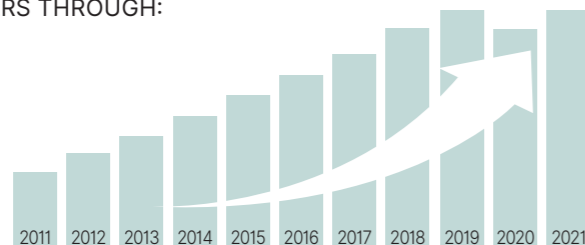

### INDUSTRIAL EXPERTISE

IN SEVERAL FIELDS

### DESIGN trendy & creativity

- ✓ Our in-house Creation Studio brings product design originality & freshness.
- ✓ Our innovative ideas perfectly fit both market needs & creative expectations of interior designers, housing specifiers & architects.
- ✓ Our moto, be different  
70% of sales are achieved with product ranges less than three years old.

### DECORATOR

- ✓ Every year, Gerflor renews its collections and reates new designs
- ✓ Designs solutions that can be combined and mixed to create custom spaces

### INNOVATIVE SOLUTION

#### GERFLOR SPIRIT

- ✓ 3 Research & Development centers dedicated to product innovation.
  - ✓ 140 engineers for ultimate flooring solutions that anticipate the needs of our customers.
  - ✓ Partnerships with laboratories and universities around the world enable Gerflor to benefit from the last materials & emerging technologies.
- Innovation distinguishes between a leader and a follower.



## EXPERT quality & choice



- ✓ Extensive product range
- ✓ Top-quality products designed for high traffic
- ✓ Highly resistant
- ✓ Solutions for all customer needs: Installation type, size, all-uses, related accessories

## CLEVER quick & easy

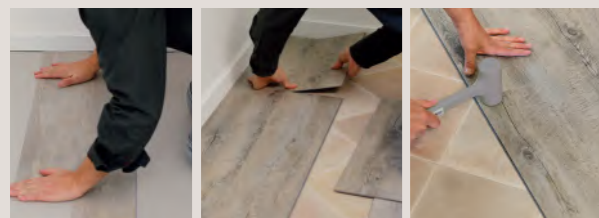

- ✓ Make life easier
- ✓ Products installed without glue and without subfloor preparation
- ✓ Optimal user-friendliness
- ✓ Can be installed with a utility knife



## INVENTOR INNOVATION FOR THE HOME

1985



**SELF-ADHESIVE TILES**  
A revolutionary Peel'n Stick product: fast and easy to lay

2006



**SENSO**  
Self adhesive planks with an ultra realistic look

2010

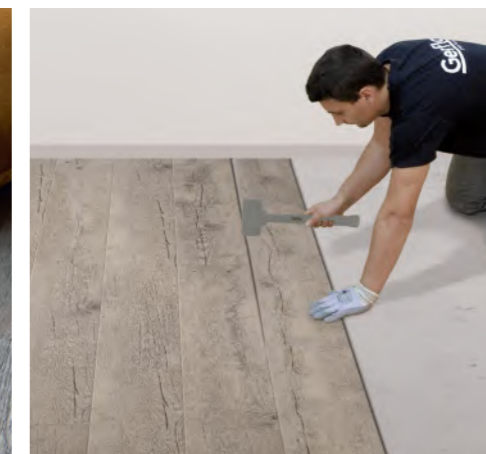

**INTERLOCKING**  
Interlocking vinyl tiles and planks

2014



**ADJUST**  
The easiest solution. No clic, no glue

2018



**SENSO CLIC PREMIUM**  
Simply the best for your floor

2020



**SENSO PREMIUM EASY**  
Looselay solution: no clic no glue.  
Mix and match design: 12 designs to associate.

2022



**SENSO PREMIUM CLIC NEW GENERATION**  
Fold down patteted Gerflor

## MARKET informations & orientations in Western Europe

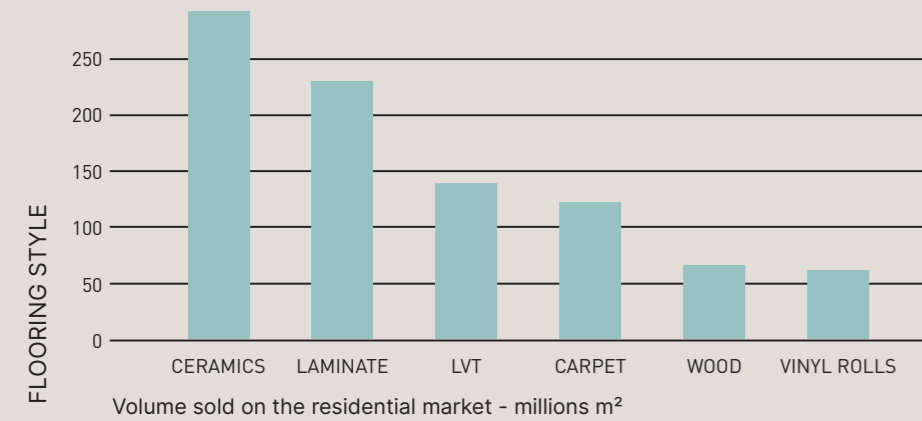

## TYPE

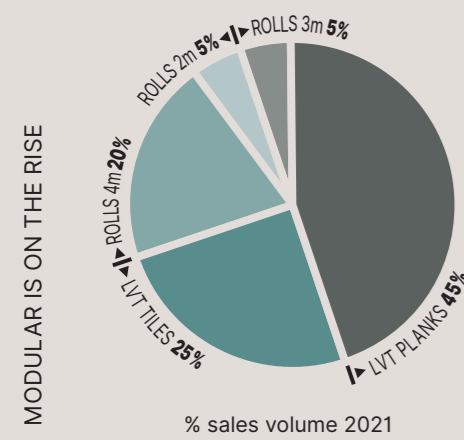

## DESIGN

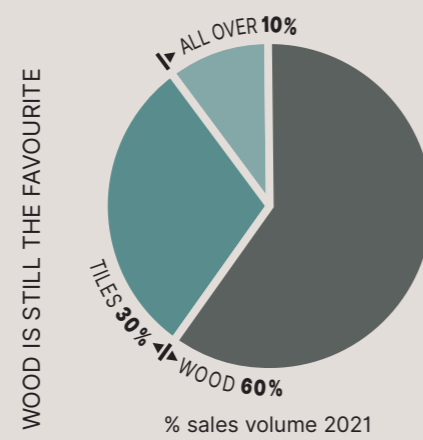

# A SOLUTION ECO-RESPONSIBLE COMMITTED TO SUSTAINABLE DEVELOPMENT

## GOING FURTHER



### RAW MATERIALS

#### HEALTHY RAW MATERIALS

- No heavy metals, no solvents, no formaldehyde.
- All materials are 100% compliant with European standards (REACH).

#### SUSTAINABLE PRODUCTS

recycled content integration



### INDOOR AIR QUALITY

#### LOW VOC EMISSIONS

- All our products conform to **Floorscore, AgBB, A+ (France) and M1 (Finlande)** standards.
- TVOC emissions after 28 days < 100 µg/m<sup>3</sup>.
- Gerflor looselay solutions (GFT rolls, tiles and snap-together planks): no glue required.

#### ▶ VOC Free system



### ENVIRONMENTAL FOOTPRINT

- All our products are **eco-designed** based on a life-cycle analysis model in order to **reduce their environmental impact**.
- Our products are regularly assessed in accordance with **ISO 16000 standards**.



### RECYCLING

- Thanks to our Second Life recycling program, **50 000 tons** of waste were recycled in 2018 by Gerflor and reinjected into our production units.
- All of our click products are made up of **55% recycled materials** (production falls, laying falls, end of life).

#### WATER CONSUMPTION SINCE 1998

Did you know?  
All inks used in the group's factories are solvent-free and water-based. The printing cylinders are cleaned with biodegradable agents and the wastewater inks are recycled by evaporation.

### LOOSELAY PRODUCTS NO GLUE VOC FREE SYSTEM



# GERFLOR DECORATION TRENDS



DEEP BLUE

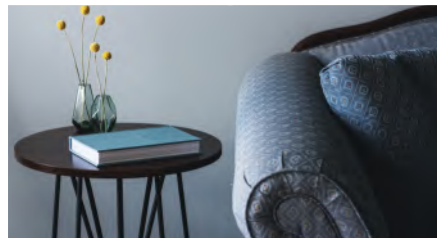

FAR AWAY



# GERFLOR DECORATION TRENDS



## MATERICO



## TIMBER CAMP

# LVT SOLUTIONS GERFLOR 2022

## MAKE THE RIGHT CHOICE!

	INTERLOCKING			LOOSELAY	SELF ADHESIVE	
	<b>NEW</b> SENSO PREMIUM CLIC	SENSO CLIC	SENSO 20 LOCK	SENSO EASY PREMIUM	SENSO SELF-ADHESIVE PREMIUM	SENSO SELF-ADHESIVE
Laying system	Looselay			Looselay	Fully adhered	
Main benefits	<ul style="list-style-type: none"> <li>New clic system: vertical small side and horizontal large side</li> <li>Quick and easy</li> </ul>	<ul style="list-style-type: none"> <li>Exclusive clic system 100% vertical</li> <li>Easy installation: just click, it's done!</li> </ul>	<ul style="list-style-type: none"> <li>Rigid structure: better stability</li> <li>Easy removable</li> </ul>	<ul style="list-style-type: none"> <li>The easiest laying solution</li> <li>No messy residue</li> </ul>	<ul style="list-style-type: none"> <li>Easy and quick installation</li> </ul>	
Price	€€€	€€	€	€€€	€	€
Tools needed	Ruler + utility knife + rubber mallet	Ruler + utility knife + rubber mallet	Ruler + utility knife	Ruler + utility knife	Ruler + utility knife	Ruler + utility knife
Thickness (mm)	4.5	4.2	3.4	4	2.5	2
Wear layer thickness (mm)	0.55	0.3	0.2	0.55	0.3	0.2
European classification	23 / 33	23 / 31	22	33 / 42	23/31	22
Traffic resistance	+++	++	+	+++	+	+
Fire rating	B <sub>fl</sub> S1	B <sub>fl</sub> S1	B <sub>fl</sub> S1	B <sub>fl</sub> S1	B <sub>fl</sub> S1	B <sub>fl</sub> S1
Sound insulation (dB)	4	4	3	4	5	3
Room impact noise	Class C	Class C	-	Class B	Class C	Class C
Compatible with wet rooms	OK	OK	OK	OK	OK	OK
Domestic use guarantee*	20 years	12 years	10 years	15 years	12 years	10 years
	Page 16	Page 26	Page 34	Page 40	Page 46	Page 52

\* For more details on guarantee, see [www.gerflor.com](http://www.gerflor.com)



## SENSO RANGE

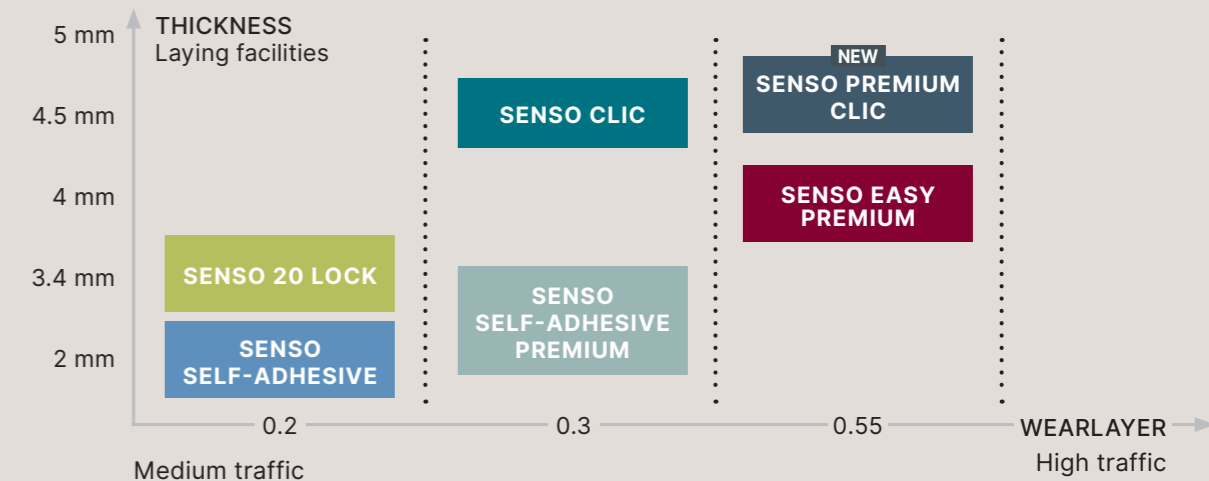

## PRODUCT BENEFITS

### + DESIGN REFERENCES

Style organised collection  
Quality of designs and embossing  
Textured surface

### ALL USES

Watertight  
Guaranteed 10- years:  
total finish (planks + grout)

### MAKES LIFE EASIER

Easy to transport: modular format  
Easy to install: adhesive or interlocking  
Easy to cut: utility knife  
Easy to clean: soapy water

### ECO-FRIENDLY

TVOC < 100 µg/m<sup>3</sup>  
100% recyclable  
Lead-free  
Formaldehyde-free  
Solvent-free  
Soapy water cleaning



### 3 INSTALLATION TECHNOLOGIES

INTERLOCKING  
LOOSELAY  
SELF-ADHESIVE



# SENSO PREMIUM CLIC



1297 - SHALE BLACK

**DUOCORE** Rigid & Comfort



EASY TO INSTALL AND CUT  
In hard-to-reach areas



DIRECT LAYING ON CERAMIC



SCRATCH RESISTANT



TRAFFIC RESISTANT



SUITABLE FOR WET ROOMS

MADE IN  
FRANCE



Scan and  
discover  
INTERIOR  
DESIGNER

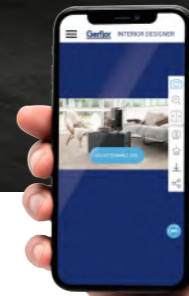

NEW



0286 - SUNNY WHITE



- 1-PECAN  
Size: 123.88 x 21.2 cm  
Code: 6053 0511 - EAN: 3475710551727
- 2-SUNNY WHITE  
Size: 123.88 x 21.2 cm  
Code: 6053 0286 - EAN: 3475710551741
- 3-KOLA  
Size: 123.88 x 21.2 cm  
Code: 6053 0309 - EAN: 3475710551734
- 4-GREENLAND GREY  
Size: 123.88 x 21.2 cm  
Code: 6053 1298 - EAN: 3475710551819
- 5-AUTHENTIC BLOND  
Size: 123.88 x 21.2 cm  
Code: 6053 0829 - EAN: 3475710551758
- 6-GREENLAND LIGHT  
Size: 123.88 x 21.2 cm  
Code: 6053 1299 - EAN: 3475710551826
- 7-COLUMBIA  
Size: 123.88 x 21.2 cm  
Code: 6053 0837 - EAN: 3475710551765

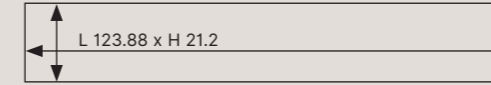

1298 - GREENLAND GREY

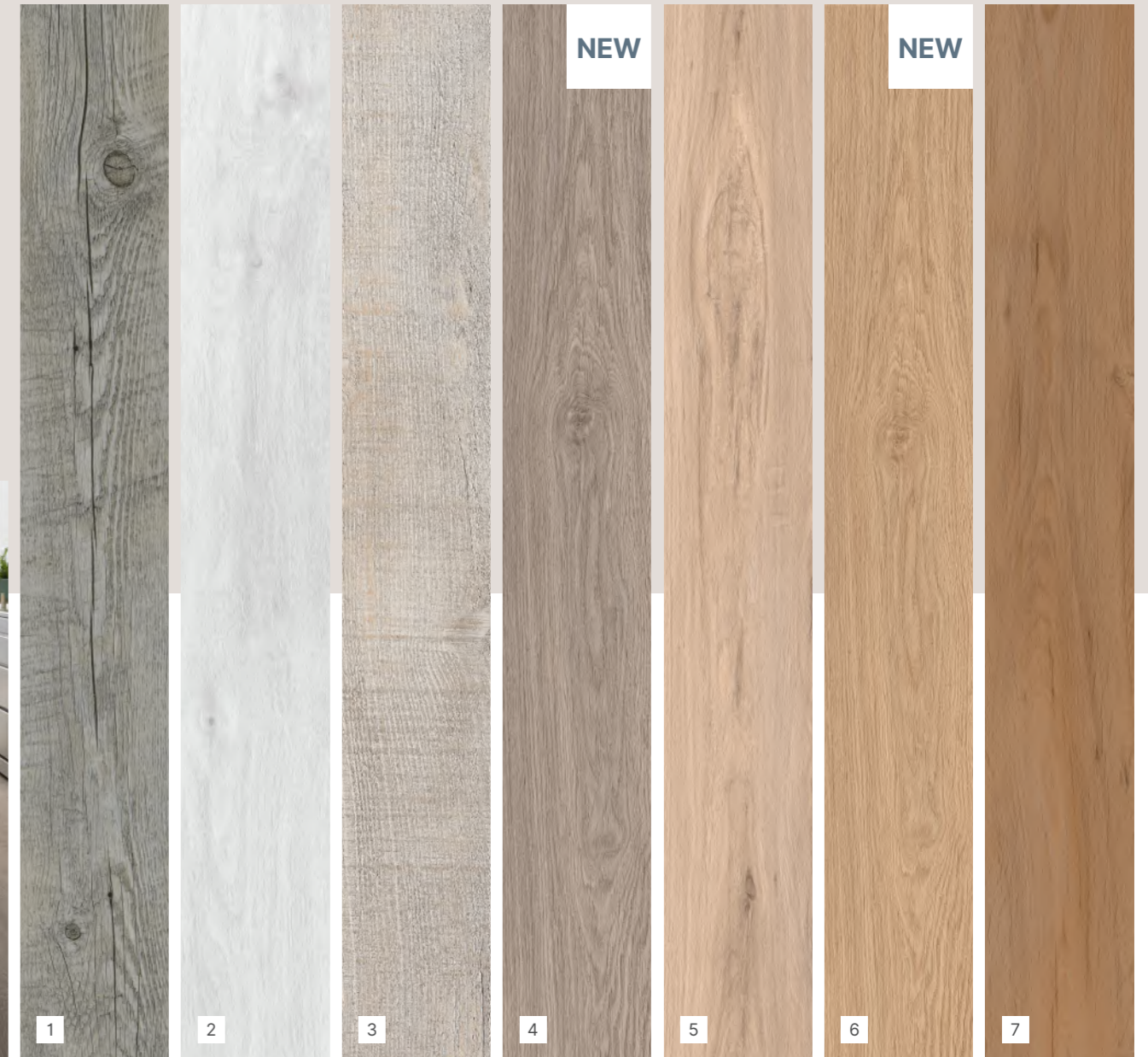

NEW



0828 - AUTHENTIC NATURE

- 1-PORTREE LIGHT  
Size: 123.88 x 21.2 cm  
Code: 6053 1207 - EAN: 3475710551802
- 2-COLUMBIA TAUPE  
Size: 123.88 x 21.2 cm  
Code: 6053 0953 - EAN: 3475710551772
- 3-AUTHENTIC NATURE  
Size: 123.88 x 21.2 cm  
Code: 6053 0828 - EAN: 3475710551789
- 4-CLEVELAND DARK  
Size: 123.88 x 21.2 cm  
Code: 6053 0728 - EAN: 3475710551796



1

2

3

4



0953 - COLUMBIA TAUPE

**NEW**



1196 - KARIBA TAUPE

**XL FORMAT**

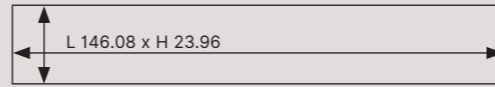

- 1-KARIBA DARK  
Size: 146.06 x 23.96 cm  
Code: 6052 1195 - EAN: 3475710551598
- 2-KARIBA BLOND  
Size: 146.06 x 23.96 cm  
Code: 6052 1213 - EAN: 3475710551611
- 3-KARIBA TAUPE  
Size: 146.06 x 23.96 cm  
Code: 6052 1196 - EAN: 3475710551604



1184 - VILLA BEIGE



- 1-GOTHA CLEAR  
Size: 72.87 x 38.88 cm  
Code: 6051 0938 - EAN: 3475710551673
- 2-MANHATTAN CLEAR  
Size: 72.87 x 38.88 cm  
Code: 6051 0826 - EAN: 3475710551666
- 3-INDUSTRY  
Size: 72.87 x 38.88 cm  
Code: 6051 0819 - EAN: 3475710551659

- 4-VILLA BEIGE  
Size: 72.87 x 38.88 cm  
Code: 6051 1184 - EAN: 3475710551697
- 5-SHALE BEIGE  
Size: 72.87 x 38.88 cm  
Code: 6051 1205 - EAN: 3475710551703
- 6-SHALE BLACK  
Size: 72.87 x 38.88 cm  
Code: 6051 1297 - EAN: 3475710551710

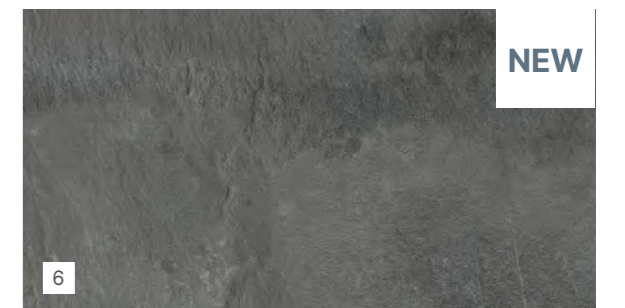
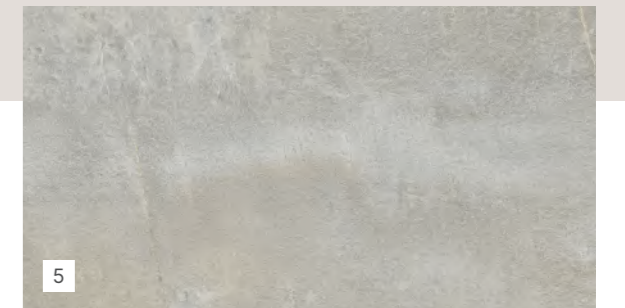
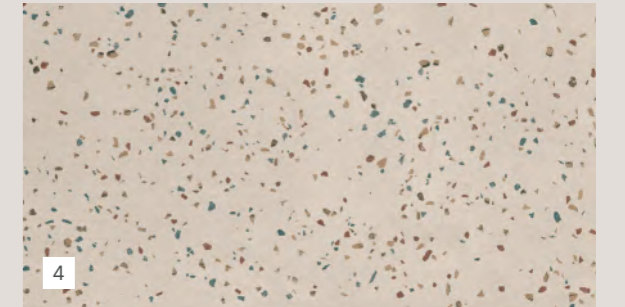
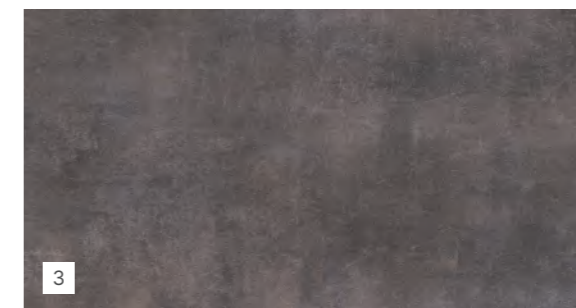
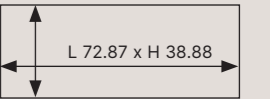

**NEW**

# TECHNICAL CHARACTERISTICS

DESCRIPTION					
Total thickness	EN ISO 24346	mm	4.5		
Thickness of wearlayer	EN ISO 24340	mm	0.55		
Weight: mass per unit area	EN ISO 23997	g/sqm	7118		
Size	EN ISO 24342	mm	planks: 212x1238.8	planks: 239.6 x 1460.8	tiles: 388.8 x 728.7
Number of planks / tiles and sqm per box	-	planks / tiles	8 planks / 2.10 sqm	7 planks / 2.45 sqm	7 tiles / 1.98 sqm

CLASSIFICATION					
Norm / Product specification	-	-	EN ISO 10582		
European classification	EN ISO 10874	class	23 / 33		
Fire rating - Classification	EN 13501-1	class	Bfl-s1		
Static electrical propensity	EN 1815	kV	< 2		
Slip resistance wet: ramp test with oil	DIN 51130	class	R10		

PERFORMANCE					
Wear resistance	EN 660.2	mm <sup>3</sup>	< 2.0		
Wear group	-	group	T		
Type binder content	ISO 10582	type	1		
Dimensional stability after exposure to heat	EN ISO 23999	%	≤ 0.15		
Residual indentation	EN ISO 24343-1	mm	≤ 0.10		
Sound insulation	EN ISO 717-2	dB	4		
Room impact noise	NF S 31074	dB	79		
Castor chair test	ISO 4918	-	OK		
Thermal conductivity	EN ISO 10456	W/(m.k)	0.25		
Colour fastness	EN 105 - B02	degree	≥ 6		
Chemical products resistance	EN ISO 26987	class	OK		
Surface treatment	-	-	Pureclean+		
Guarantee for residential use	-	year	20		

ENVIRONMENT / INDOOR AIR QUALITY					
TVOC after 28 days	ISO 16000-6	µg/m <sup>3</sup>	< 10		

CE MARKING					
	EN 14041				

Areas of use: domestic use

Composition 100% REACH Phthalate free (except recycled content)

MADE IN FRANCE



Scan and discover THE COMPLETE RANGE



- HEALTH**
- Formaldehyde-free
  - Lead-free, no heavy metals
  - Solvent-free
  - No harmful plasticizer
  - Low VOC emission
  - No glue

- TVOC < 10 µg/m<sup>3</sup> after 28 days
- ENVIRONMENT**
- ISO 14001
  - Soapy water cleaning

# LAYING

## 1 important

[www.gerflor.com](http://www.gerflor.com)

Check batch numbers: N° BATCH X

Temperature range: Maxi 35°C / 95°F, Mini 8°C / 46°F

Substrate requirements: < 5 mm - 1/4", < 2 mm - 5/64"

Substrate requirements: > 5 mm - 1/4", > 2 mm - 5/64"

Do not use on carpet.

## 2 preparation

Temperature range: > 15°C / 60°F, < 26°C / 80°F, > 20°C / 70°F

CCM: < 7% CCM, < 92% RH

Substrate preparation: 2 m, < 5 mm, ASTM F710 3/16" per 10'

Substrate preparation: 20 cm, < 1 mm

Tools: Hammer, pencil, utility knife, gloves.

## 3 installation

Installation steps 1, 2, 3.

Staggering: min. 1/3, min. 1/3

Expansion gap: 5 mm - 1/4", 4 - 5 mm - 1/8" - 1/4"

Substrate: min. 1/3, min. 1/3

Tools: Hammer, tapping block, spacers.

## 4 maintenance

Do not use abrasive cleaners or sharp objects.

Weight limit: > 30 kg/cm<sup>2</sup> / > 175 psi

Cleaning: see page 65

[www.gerflor.com](http://www.gerflor.com)

# SENSO PREMIUM CLIC

Product information and technical details for Senso Premium Clic.

100% RECYCLED CONTENT 100% RECYCLABLE

Gerflor logo and contact information.

# SENSO CLIC



1028 - SIMBA NATURE

**DUOCORE** Rigid & Comfort



100% EASY COVERING  
(even corners, walls, pillars...)



VERTICAL CLIC



DIRECT LAYING ON CERAMIC



RESISTANT



100% WATERPROOF



Scan and discover  
INTERIOR  
DESIGNER

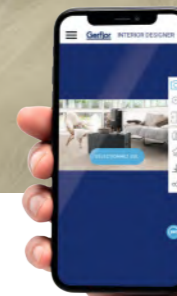



0286 - COTON OAK

- 1-COTON OAK  
Size: 123.9 x 21.4 cm  
Code: 6026 0286 - EAN: 3475710527852
- 2-TACANA BLOND  
Size: 123.9 x 21.4 cm  
Code: 6026 1174 - EAN: 3475710522888
- 3-TACANA GREY  
Size: 123.9 x 21.4 cm  
Code: 6026 1173 - EAN: 3475710522871
- 4-PECAN  
Size: 123.9 x 21.4 cm  
Code: 6026 0511 - EAN: 3475710435935
- 5-COLUMBIA PEARL  
Size: 123.9 x 21.4 cm  
Code: 6026 0954 - EAN: 3475710435966
- 6-PECAN NATURE  
Size: 123.9 x 21.4 cm  
Code: 6026 0950 - EAN: 3475710435942
- 7-SIMBA NATURE  
Size: 123.9 x 21.4 cm  
Code: 6026 1028 - EAN: 3475710438189
- 8-LORD HONEY  
Size: 123.9 x 21.4 cm  
Code: 6026 0955 - EAN: 3475710435973
- 9-MAKONDE  
Size: 123.9 x 21.4 cm  
Code: 6026 1248 - EAN: 3475710543487
- 10-PECAN LIGHT  
Size: 123.9 x 21.4 cm  
Code: 6026 1300 - EAN: 3475710551888

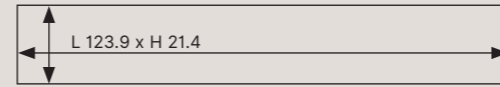

1

2

3



4

5

6

7

8



1248 - MAKONDE

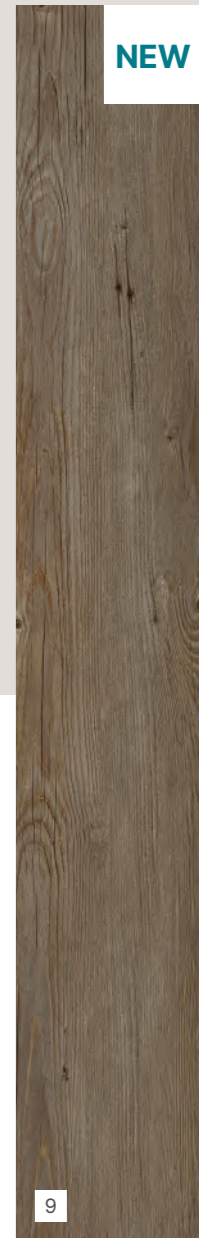

NEW

9



NEW

10

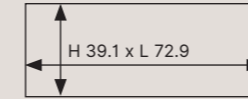

1

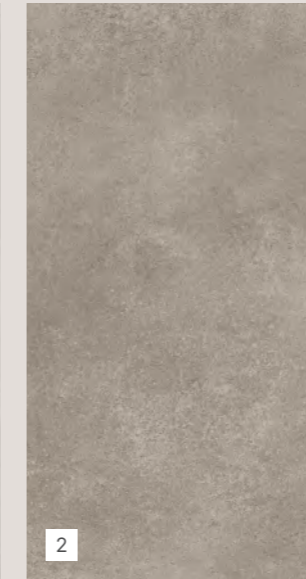

2



3

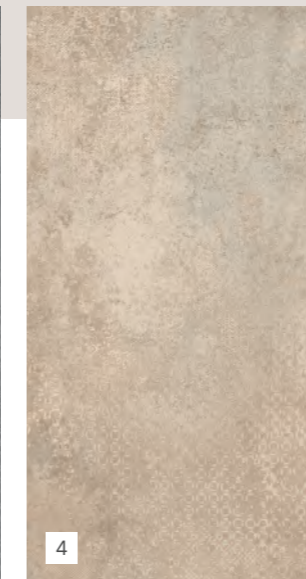

4

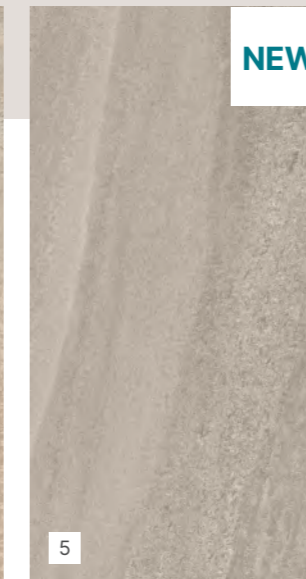

5



6

- 1-PEPPER LIGHT**  
Size: 72.9 x 39.1 cm  
Code: 6027 0890 - EAN: 3475710438202
- 2-PEPPER TAUPE**  
Size: 72.9 x 39.1 cm  
Code: 6027 0889 - EAN: 3475710438219
- 3-PETRA BLACK**  
Size: 72.9 x 39.1 cm  
Code: 6027 1183 - EAN: 3475710523144
- 4-PETRA BEIGE**  
Size: 72.9 x 39.1 cm  
Code: 6027 1182 - EAN: 3475710523137
- 5-KANDY CLEAR**  
Size: 72.9 x 39.1 cm  
Code: 6027 1247 - EAN: 3475710543470
- 6-KANDY GREY**  
Size: 72.9 x 39.1 cm  
Code: 6027 1246 - EAN: 3475710543463



0890 - PEPPER LIGHT



# TECHNICAL CHARACTERISTICS

DESCRIPTION				
Total thickness	EN ISO 24346	mm	4.20	
Thickness of wearlayer	EN ISO 24340	mm	0.30	
Weight: Mass per unit area	EN ISO 23997	g/sqm	7385	
Size	EN ISO 24342	cm	planks: 123.9 x 21.4	tiles: 72.9 x 39.1
Number of planks / tiles and sqm per box	-	planks / tiles	8 planks / 2.12 sqm	8 tiles / 2.28 sqm

CLASSIFICATION				
Norm / Product specification	-	-	EN ISO 10582	
European classification	EN ISO 10874	class	23/31	
Fire rating - Classification	EN 13501-1	class	B <sub>fl</sub> -s1	
Static electrical propensity	EN 1815	kV	< 2	
Slip resistance wet: ramp test with oil	DIN 51130	class	R10	

PERFORMANCE				
Wear resistance	EN 660.2	mm <sup>3</sup>	< 2.0	
Wear group	-	group	T	
Type binder content	ISO 10582	type	I	
Dimensional stability after exposure to heat	EN ISO 23999	%	≤ 0.15	
Residual indentation	EN ISO 24343-1	mm	≤ 0.10	
Sound insulation	EN ISO 717-2	dB	4	
Room impact noise	NF S 31074	dB	78	
Castor chair test (Type W)	ISO 4918	-	OK	
Thermal conductivity	EN ISO 10456	W/(m.k)	0.25	
Colour fastness	EN 20 105 - B02	degree	≥ 6	
Chemical products resistance	EN ISO 26987	class	OK	
Surface treatment	-	-	PUR+ Matt	
Guarantee for residential use	-	year	12	

ENVIRONMENT / INDOOR AIR QUALITY				
TVOC after 28 days	ISO 16000-6	µg/m <sup>3</sup>	< 10	

**CE MARKING**

CE EN 14041

**Areas of use: domestic use**

Composition 100% REACH Phthalate free (except recycled content)



Scan and discover THE COMPLETE RANGE

**HEALTH**

- Formaldehyde-free
- Lead-free, no heavy metals
- Solvent-free
- No harmful plasticizer
- Low VOC emission
- No glue

TVOC < 10 µg/m<sup>3</sup> after 28 days

**ENVIRONMENT**

- ISO 14001
- Soapy water cleaning

# LAYING

## 1 important

## 2 preparation

## 3 installation

## 4 maintenance

Cleaning - see page 65

# SENSO CLIC

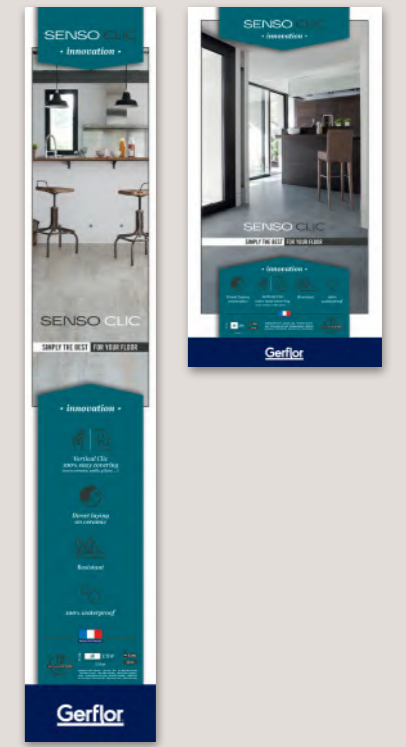

# SENSO 20 LOCK



1093 - CASHEW CLEAR

**CLICK...**  
IT'S DONE!



**QUICK & EASY INSTALLATION**

No glue / Can be trimmed with an utility knife



**RESISTANT**

Shock-resistant varnish /  
0.20mm wearlayer - thickness 3.4 mm



**RIGID STRUCTURE**



**SUITABLE FOR WET ROOMS**

Watertight and slip-resistant



**GUARANTEE 10 YEARS**

Domestic use



Scan and discover  
**INTERIOR  
DESIGNER**



- 1-BRICKELL DARK  
Size: 60.2 x 29.8 cm  
Code: 3667 1119 - EAN: 3475710445477
- 2-TUSCAN  
Size: 60.2 x 29.8 cm  
Code: 3667 1090 - EAN: 3475710445422
- 3-BRICKELL GREY  
Size: 60.2 x 29.8 cm  
Code: 3667 1099 - EAN: 3475710445460
- 4-DEW BEIGE  
Size: 121 x 17.7 cm  
Code: 3668 1091 - EAN: 3475710445439
- 5-LUMBER TAUPE  
Size: 121 x 17.7 cm  
Code: 3668 1095 - EAN: 3475710445521
- 6-LUMBER FAUVE  
Size: 121 x 17.7 cm  
Code: 3668 1096 - EAN: 3475710445538
- 7-LUMBER GREY  
Size: 121 x 17.7 cm  
Code: 3668 1097 - EAN: 3475710445545
- 8-CASHEW CLEAR  
Size: 121 x 17.7 cm  
Code: 3668 1093 - EAN: 3475710445507

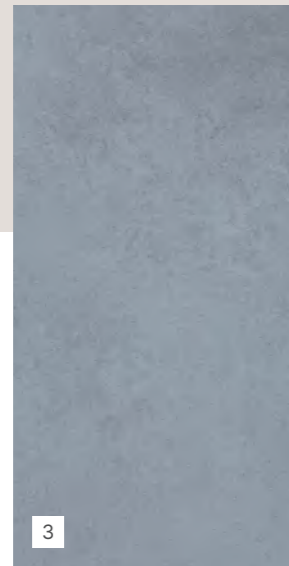
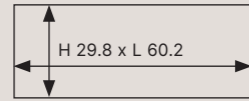

1119 - BRICKELL DARK

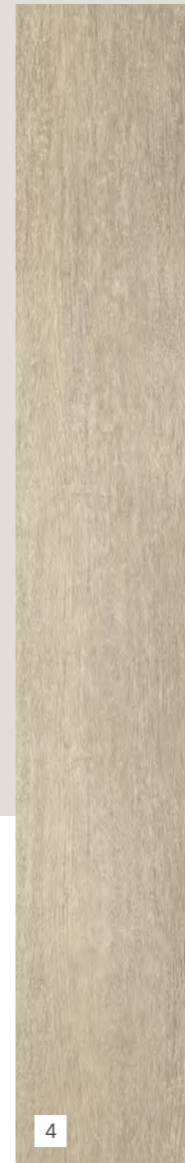

1091 - DEW BEIGE

# TECHNICAL CHARACTERISTICS

DESCRIPTION				
Total thickness	EN ISO 24346	mm	3.40	
Thickness of wearlayer	EN ISO 24340	mm	0.20	
Weight	EN ISO 23997	g/sqm	6360	
Size	EN ISO 24342	cm	planks: 17.7 x 121	tiles: 29.8 x 60.2
Number of planks / tiles and sqm per box	-	planks/tiles	9 planks / 1.93 sqm	11 tiles / 1.97 sqm

CLASSIFICATION				
Norm / Product specification	-	-	EN ISO 10582	
European classification	EN ISO 10874	class	22	
Fire rating - Classification	EN 13501-1	class	Bfl-s1	
Static electrical propensity	EN 1815	kV	< 2	

PERFORMANCE				
Wear group	-	group	T	
Dimensional stability after exposure to heat	EN ISO 23999	%	≤ 0.15	
Residual indentation	EN ISO 24343-1	mm	≤ 0.10	
Sound insulation	EN ISO 717-2	dB	3	
Room impact noise	NF S 31074	dB	78	
Thermal conductivity	EN ISO 10456	W/(m.k)	0.25	
Colour fastness	EN 20 105 - B02	degree	≥ 6	
Chemical products resistance	EN ISO 26987	class	OK	
Surface treatment	-	-	PUR+	
Guarantee for residential use	-	year	10	

ENVIRONMENT / INDOOR AIR QUALITY				
TVOC after 28 days	ISO 16000-6	µg/m³	< 100	

CE MARKING				
CE	EN 14041			

Areas of use: domestic use

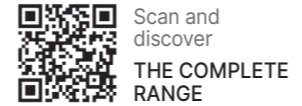

- HEALTH**
- Formaldehyde-free
  - Lead-free, no heavy metals
  - Solvent-free
  - No harmful plasticizer
  - Low VOC emission
  - No glue

TVOC < 100 µg/m³ after 28 days

- ENVIRONMENT**
- ISO 14001
  - Soapy water cleaning

# LAYING

## 1 important

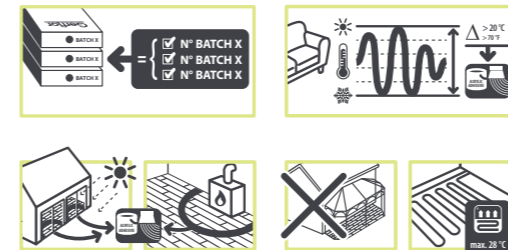

## 2 preparation

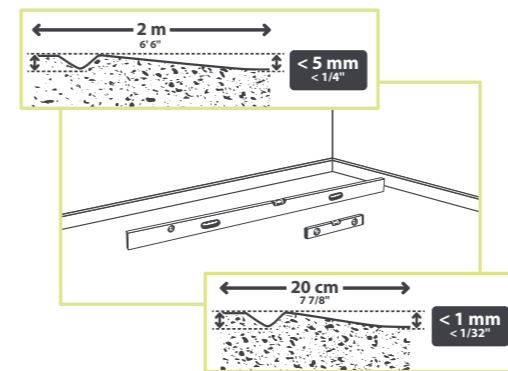
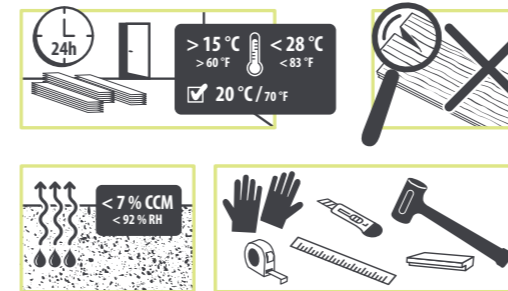

## 3 installation

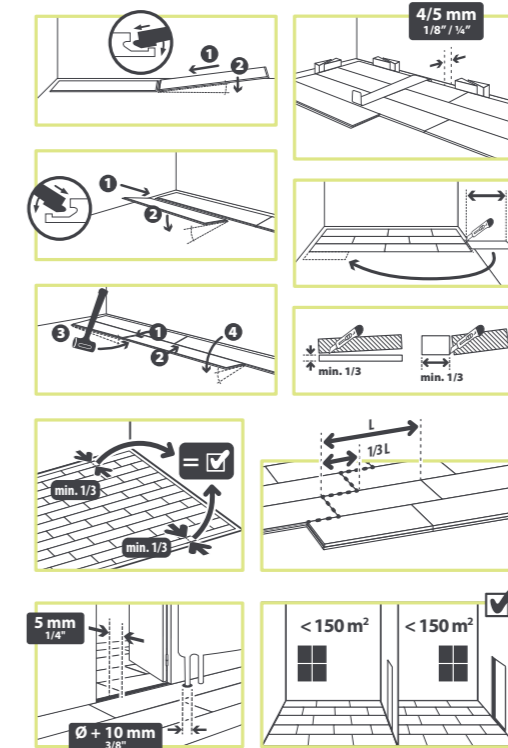

## 4 maintenance

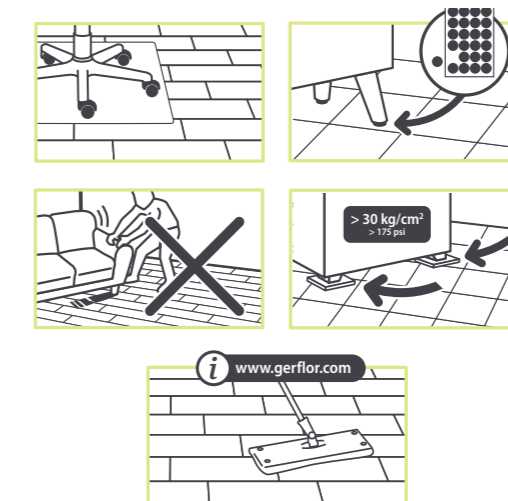

Cleaning - see page 65

# SENSO 20 LOCK



# SENSO EASY

PREMIUM



1034 - CORDOBA BLACK / 0780 - FLAGSTONE DARK

## LOOSELAY

NO CLIC NO GLUE



REINFORCED STRUCTURE



DIRECT LAYING ON CERAMIC



LEAVES THE SUBFLOOR INTACT



EASY MIX AND MATCH



NO DILATATION



SUITABLE FOR WET ROOMS



Scan and discover  
INTERIOR  
DESIGNER

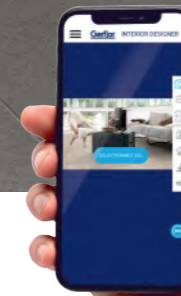



- 1-SYMBA GREY  
Size: 121.9 x 18.4 cm  
Code: 3617 0888 - EAN: 3475710439476
- 2-HELLA WHITE  
Size: 121.9 x 18.4 cm  
Code: 3617 0035 - EAN: 3475710438035
- 3-ROSEBUD PEARL  
Size: 121.9 x 18.4 cm  
Code: 3617 0506 - EAN: 3475710438004
- 4-LORD LIGHT  
Size: 121.9 x 18.4 cm  
Code: 3617 1027 - EAN: 3475710438042
- 5-PUZZLE  
Size: 121.9 x 18.4 cm  
Code: 3617 0385 - EAN: 3475710438011



- 1-CORDOBA BLACK  
Size: 61 x 61 cm  
Code: 3618 1034 - EAN: 3475710438271
- 2-CORDOBA IVORY  
Size: 61 x 61 cm  
Code: 3618 1033 - EAN: 3475710438264
- 3-PROVENCE BLUE  
Size: 61 x 61 cm  
Code: 3618 0917 - EAN: 3475710438240
- 4-PROVENCE GOLD  
Size: 61 x 61 cm  
Code: 3618 1032 - EAN: 3475710438257
- 5-FLAGSTONE DARK  
Size: 61 x 30.5 cm  
Code: 3616 0780 - EAN: 3475710439421
- 6-WALLSTREET LIGHT  
Size: 61 x 30.5 cm  
Code: 3616 0702 - EAN: 3475710439438
- 7-GOTHA CLEAR  
Size: 61 x 30.5 cm  
Code: 3616 0938 - EAN: 3475710439414

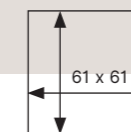

1032 - PROVENCE GOLD / 1027 - LORD LIGHT

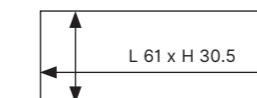

# TECHNICAL CHARACTERISTICS

DESCRIPTION					
Total thickness	EN ISO 24346	mm	4.0		
Thickness of wearlayer	EN ISO 24340	mm	0.55		
Weight: Mass per unit area	EN ISO 23997	g/sqm	7200		
Size	EN ISO 24342	cm	planks: 18.4 x 121.9	tiles: 30.5 x 61	tiles: 61 x 61
Number of planks / tiles and sqm per box	-	planks / tiles	8 planks / 1.79 sqm	10 tiles / 1.86 sqm	4 tiles / 1.49 sqm

CLASSIFICATION			
Norm / Product specification	-	-	EN ISO 10582
European classification	EN ISO 10874	class	33/42
Fire rating - Classification	EN 13501-1	class	Bfl-s1
Static electrical propensity	EN 1815	kV	< 2
Slip resistance wet: ramp test with oil	DIN 51130	class	R9

PERFORMANCE			
Wear group	EN 649	group	T
Dimensional stability after exposure to heat	EN ISO 23999	%	≤ 0.15
Residual indentation	EN ISO 24343-1	mm	≤ 0.10
Sound insulation	EN ISO 717-2	dB	4
Room impact noise	NF S 31074	dB	75
Thermal conductivity	EN ISO 10456	W/(m.k)	0.25
Colour fastness	EN 20 105 - B02	degree	≥ 6
Surface treatment	-	-	PUR+ Matt
Guarantee for residential use	-	year	15

ENVIRONMENT / INDOOR AIR QUALITY			
TVOC after 28 days	ISO 16000-6	µg/m³	< 100

CE MARKING	
CE	EN 14041

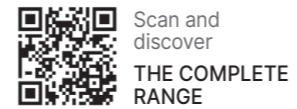

- HEALTH**
- Formaldehyde-free
  - Lead-free, no heavy metals
  - Solvent-free
  - No harmful plasticizer
  - Low VOC emission
  - No glue

TVOC < 100 µg/m³ after 28 days

- ENVIRONMENT**
- ISO 14001
  - Soapy water cleaning

# LAYING

## 1 important

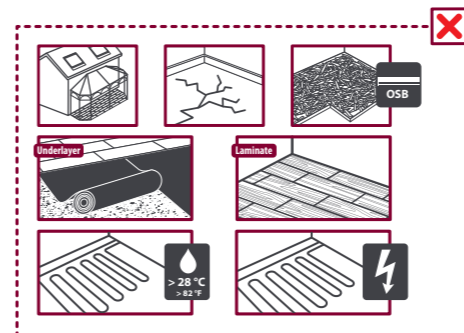

## 2 preparation

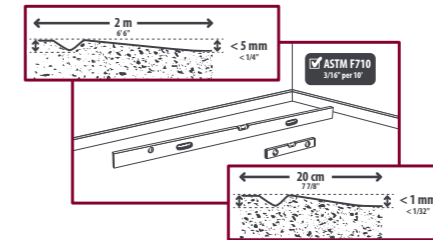

## 3 installation

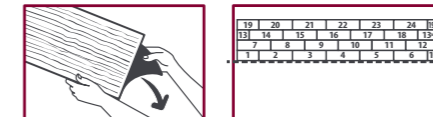
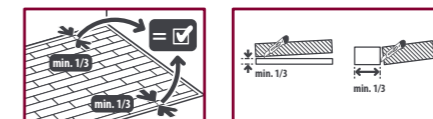

## 4 maintenance

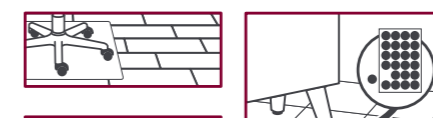

# SENSO EASY PREMIUM

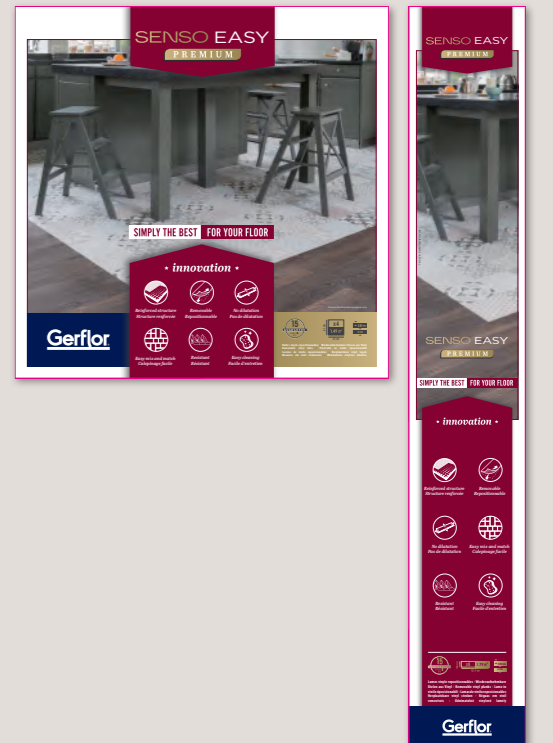

LVT TILES  
LOOSELAY

★ *innovation* ★

SENSO  
SELF-ADHESIVE

PREMIUM



0912 - BALADE LIGHT

**SIMPLY THE BEST  
FOR YOUR FLOOR**

ULTRA STEADY  
ULTRA RESISTANT  
ULTRA EASY

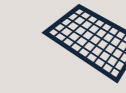

REINFORCED STRUCTURE



NO GAP



REINFORCED ADHESIVE



RESISTANT



NO DILATATION



EASY CLEANING



Scan and  
discover  
INTERIOR  
DESIGNER

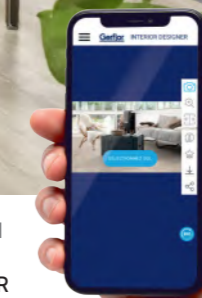





1303 - ALTA SKIN



1 Synchronised emboss

2 Synchronised emboss

3 Synchronised emboss

4

5

6

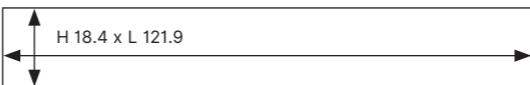

1034 - CORDOBA BLACK

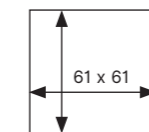

- 1-BALADE HONEY  
Size: 121.9 x 18.4 cm  
Code: 3579 0909 - EAN: 3475710431401
- 2-BALADE GREY  
Size: 121.9 x 18.4 cm  
Code: 3579 0910 - EAN: 3475710431418
- 3-BALADE LIGHT  
Size: 121.9 x 18.4 cm  
Code: 3579 0912 - EAN: 3475710431425
- 4-ALTA SKIN  
Size: 121.9 x 18.4 cm  
Code: 35791303 - EAN: 3475710555282
- 5-ALTA CLEAR  
Size: 121.9 x 18.4 cm  
Code: 35791302 - EAN: 3475710555275
- 6-SIMBA  
Size: 121.9 x 18.4 cm  
Code: 3579 0287 - EAN: 3475710428913
- 7-PEPPER LIGHT  
Size: 61 x 61 cm  
Code: 3578 0890 - EAN: 3475710428876
- 8-PEPPER TAUPE  
Size: 61 x 61 cm  
Code: 3578 0889 - EAN: 3475710428869
- 9-PROVENCE GOLD  
Size: 61 x 61 cm  
Code: 3578 0920 - EAN: 3475710431463
- 10-PROVENCE GREY  
Size: 61 x 61 cm  
Code: 3578 0919 - EAN: 3475710431456
- 11-CORDOBA BLACK  
Size: 61 x 61 cm  
Code: 3578 1034 - EAN: 3475710551543
- 12-CORDOBA IVORY  
Size: 61 x 61 cm  
Code: 3578 1033 - EAN: 3475710551536

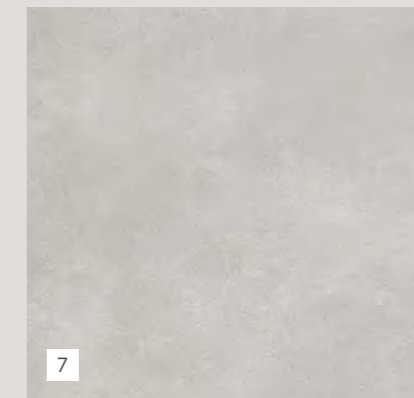

7

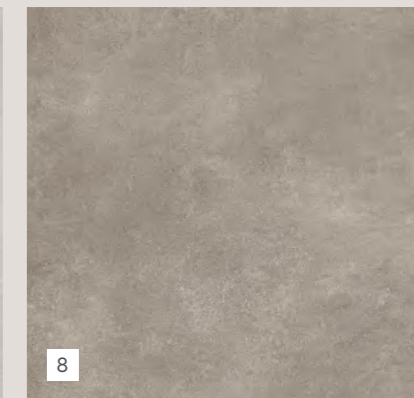

8



9



10

Registered cutting

Registered cutting



11

NEW



12

NEW

# TECHNICAL CHARACTERISTICS

DESCRIPTION				
Total thickness	EN ISO 24346	mm	2.50	
Thickness of wearlayer	EN ISO 24340	mm	0.30	
Weight: mass per unit area	EN ISO 23997	g/sqm	4660	
Size	EN ISO 24342	cm	planks: 121.9 x 18.4	tiles: 61 x 61
Number of planks / tiles and sqm per box	EN ISO 24342	planks / tiles	11 planks / 2.47 sqm	7 tiles / 2.60 sqm

CLASSIFICATION				
Norm / Product specification	-	-	EN ISO 10582	
European classification	EN ISO 10874	class	23/31	
Fire rating - Classification	EN 13501-1	class	B <sub>f1</sub> -s1	
Static electrical propensity	EN 1815	kV	< 2	

PERFORMANCE				
Wear resistance	EN 660.2	mm <sup>3</sup>	< 2.0	
Wear group	EN 649	group	T	
Type binder content	ISO 10582	type	I	
Dimensional stability after exposure to heat	EN ISO 23999	%	≤ 0.10	
Residual indentation	EN ISO 24343-1	mm	≤ 0.10	
Sound insulation	EN ISO 717-2	dB	5	
Room impact noise	NF S 31074	dB	77	
Thermal conductivity	EN ISO 10456	W/(m.k)	0.25	
Colour fastness	EN 20 105 - B02	degree	≥ 6	
Surface treatment	-	-	PUR+	
Guarantee for residential use	-	year	12	

ENVIRONMENT / INDOOR AIR QUALITY				
TVOC after 28 days	ISO 16000-6	µg/m <sup>3</sup>	< 100	

CE MARKING				
CE	EN 14041			

Areas of use: domestic use



Composition 100 % REACH Phthalate free



Scan and discover THE COMPLETE RANGE



### HEALTH

- Formaldehyde-free
- Lead-free, no heavy metals
- Solvent-free
- No harmful plasticizer
- Low VOC emission

TVOC < 100 µg/m<sup>3</sup> after 28 days

### ENVIRONMENT

- ISO 14001
- Soapy water cleaning

# LAYING

## 1 important

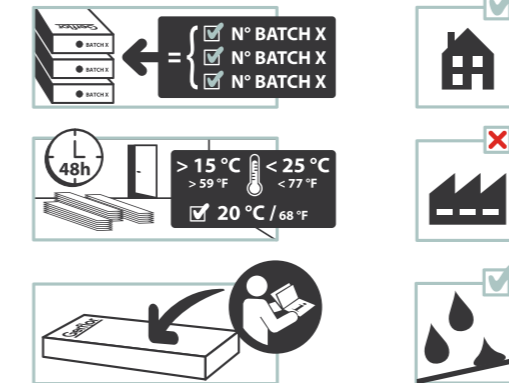

## 2 preparation



## 3 installation

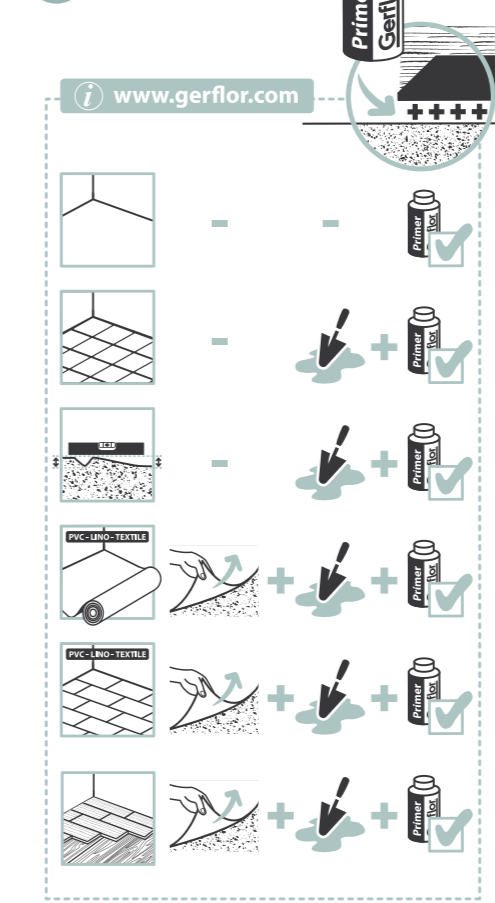

## 4 maintenance

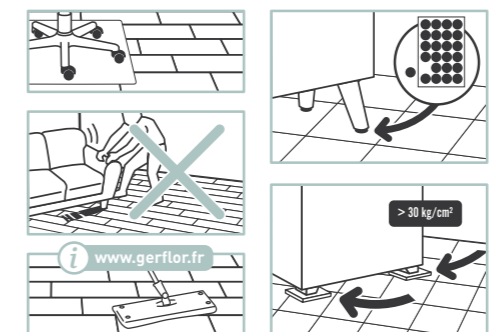

Cleaning - see page 65

# SENSO SELF-ADHESIVE PREMIUM

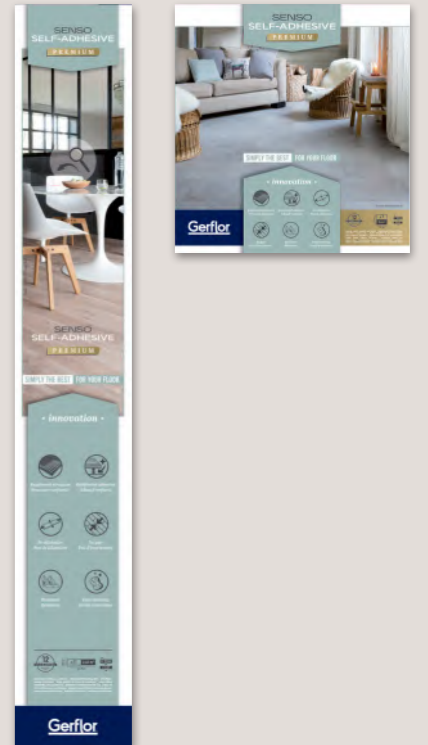

LVT TILES SELF ADHESIVE

# SENSO SELF-ADHESIVE



0511 - PECAN

## INSTALLED QUICKLY & EASILY!



**ULTRA-REALISTIC**  
4 bevelled edges  
Textured surface



**TRENDY**  
3 styles that reflect consumers  
taste



**QUICK & EASY INSTALLATION**



No glue, no joints, no spacers  
Can be cut with a utility knife  
Dust-free  
15 m<sup>2</sup> (160 sq. ft.) per hour



**RESISTANT**



**WATER RESISTANT**



Scan and  
discover  
**INTERIOR  
DESIGNER**



## SENSO RUSTIC

- 1-PECAN**  
**AS:** Size: 91.4 x 15.2 cm  
**Code:** 3325 0511 - EAN: 3475710247514  
**BD:** Size: 91.4 x 15.2 cm  
**Code:** 3327 0511 - EAN: 3475710250385
- 2-WHITE PECAN**  
**AS:** Size: 91.4 x 15.2 cm  
**Code:** 3325 0394 - EAN: 3475710304651
- 3-KOLA**  
**AS:** Size: 91.4 x 15.2 cm  
**Code:** 3325 0309 - EAN: 3475710247538
- 4-MUSCADE**  
**BD:** Size: 91.4 x 15.2 cm  
**Code:** 3327 0306 - EAN: 3475710250408
- 5-NOISETTE**  
**BD:** Size: 91.4 x 15.2 cm  
**Code:** 3327 0311 - EAN: 3475710250392

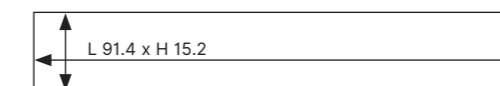

0311 - NOISETTE



0394 - WHITE PECAN



## SENSO NATURAL



NEW



1

2

3

4

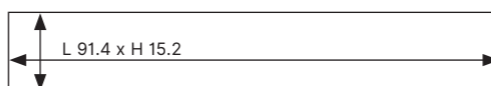

- 1-SUNNY LIGHT  
VS: Size: 91.4 x 15.2 cm  
Code: 3280 0996 - EAN: 3475710551550
- 2-COLUMBIA  
VS: Size: 91.4 x 15.2 cm  
Code: 3280 0347 - EAN: 3475710391088
- 3-NOYER NATUREL  
VS: Size: 91.4 x 15.2 cm  
Code: 3280 0018 - EAN: 3475710235238
- 4-MERBAU EXOTIC  
VS: Size: 91.4 x 15.2 cm  
Code: 3280 0019 - EAN: 3475710235245
- 5-TRAVERTIN  
VS: Size: 30.5 x 60.9 cm  
Code: 3374 0201 - EAN: 3475710320385
- 6-NIGHT SLATE  
VS: Size: 30.5 x 60.9 cm  
Code: 3374 0397 - EAN: 3475710319419



0201 - TRAVERTIN

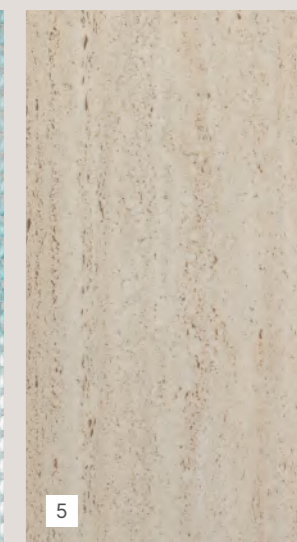

5

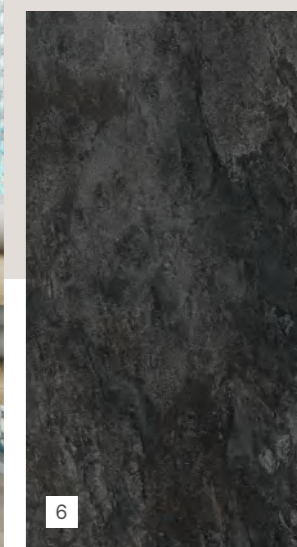

6

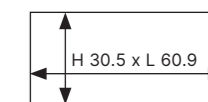



## SENSO URBAN

### 1-WALLSTREET LIGHT

Size: 30.5 x 60.9 cm

Code: 3375 0702 - EAN: 3475710391095

### 2-PROVENCE BLUE

Size: 30.5 x 60.9 cm

Code: 3375 0917 - EAN: 3475710431432

### 3-CERUSE BLANC

VS: Size: 91.4 x 15.2 cm

Code: 3326 0301 - EAN: 3475710247897

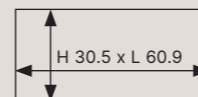

1



2

Registered cutting



0301 - CERUSE BLANC

3

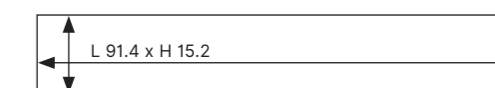

# TECHNICAL CHARACTERISTICS

DESCRIPTION	PLANKS		TILES	
	Total thickness	EN ISO 24346	mm	2.00
Thickness of wearlayer	EN ISO 24340	mm	0.20	0.20
Weight: mass per unit area	EN ISO 23997	g/sqm	3920	3425
Size	EN ISO 24342	cm	planks: 91.4 x 15.2	tiles: 30.5 x 60.9
Number of planks / tiles and sqm per box	-	planks / tiles	16 planks / 2.20 sqm	12 tiles / 2.22 sqm

CLASSIFICATION				
Norm / Product specification	-	ISO 10582	ISO 10582	ISO 10582
European classification	EN ISO 10874	class	22	22
Fire rating - Classification	EN 13501-1	class	Bfl S1	Bfl S1
Static electrical prospersity	EN 1815	-	< 2 kV	< 2 kV
Slip resistance wet: ramp test with oil	DIN 51130	class	R9	R9

PERFORMANCE				
Wear group	EN 649	group	T	T
Dimensional stability after exposure to heat	EN ISO 23999	%	≤ 0.25	≤ 0.25
Residual Indentation	EN ISO 24343-1	mm	0.05	0.05
Impact sound insulation	EN ISO 717-2	dB	3	3
Room impact noise	NF S 31074	class	C	C
Thermal conductivity	EN ISO 10456	W(m.k)	0.25	0.25
Colour fastness	EN 20 105 - B02	degree	≥ 6	≥ 6
Surface treatment	-	-	PUR	PUR
Garantee for residential use	-	year	10	10

ENVIRONMENT / INDOOR AIR QUALITY				
TVOC after 28 days	ISO 16000-6	µg/m³	< 100	< 100
VOC rating (French norm)	-	-	A+	A+

CE MARKING				
	EN 14041			

**Areas of use:** domestic use

Composition 100% REACH Phtalate free



Scan and discover THE COMPLETE RANGE

**HEALTH**

- Formaldehyde-free
- Lead-free, no heavy metals
- Solvent-free
- No harmful plasticizer
- Low VOC emission

TVOC < 100 µg/m³ after 28 days

**ENVIRONMENT**

- ISO 14001
- Soapy water cleaning

# LAYING

## 1 important

N° BATCH X  
 N° BATCH X  
 N° BATCH X

48h

> 15 °C / > 59 °F  
 < 25 °C / < 77 °F  
 20 °C / 68 °F

## 2 preparation

## 3 installation

www.gerflor.com

Primer Gerflor

## 4 maintenance

www.gerflor.fr

> 30 kg/cm²

Cleaning - see page 65

# SENSO SELF-ADHESIVE

Gerflor

SENSO URBAN

SENSO NATURAL

SENSO RUSTIC

10

x16 2.20 m²

Gerflor

SENSO URBAN

SENSO NATURAL

10

x16 2.20 m²

# Vinyl tiles

SELF-ADHESIVES



**DECORATIVE**  
2 styles that reflect consumer tastes



**ECO-FRIENDLY**  
Garanteed lead-free and formaldehyde-free



**COMPACT**  
Exclusive underlayer for long-lasting stability



0135 - MARBLE BEIGE

DESIGN



PRIME



Scan and discover  
INTERIOR DESIGNER

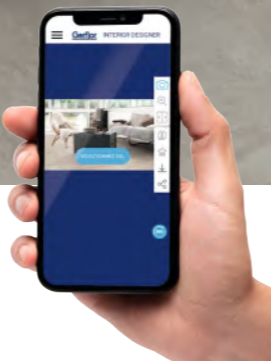

## DESIGN



1



2



3

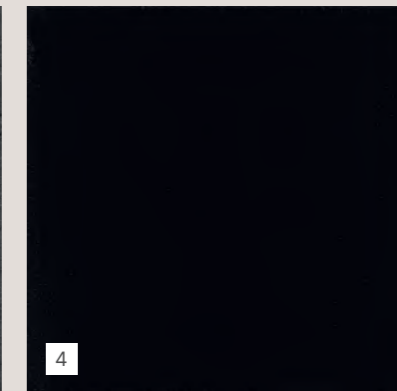

4

- 1-WHITE TILE  
Size: 30.5 x 30.5 cm  
Code: 3237 0224 - EAN: 3475710186844
- 2-SQUARE MEDIUM  
Size: 30.5 x 30.5 cm  
Code: 3237 0632 - EAN: 3475710319341
- 3-SLATE ANTHRACITE  
Size: 30.5 x 30.5 cm  
Code: 3237 0220 - EAN: 3475710186820
- 4-BLACK TILE  
Size: 30.5 x 30.5 cm  
Code: 3237 0221 - EAN: 3475710186837



## PRIME

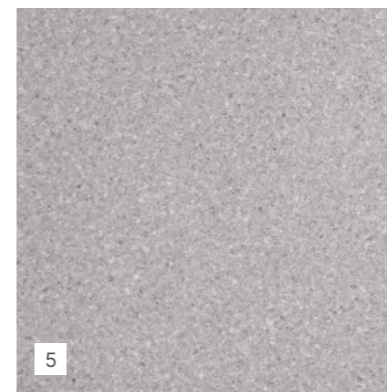

5



6

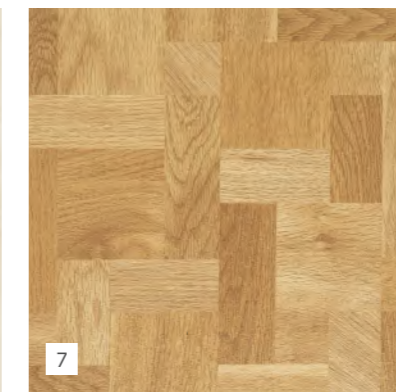

7

- 5-GRANITE GREY  
Size: 30.5 x 30.5 cm  
Code: 4556 0130 - EAN: 3475710099380
- 6-MARBLE BEIGE  
Size: 30.5 x 30.5 cm  
Code: 4556 0135 - EAN: 3475710099410
- 7-WOOD CLEAR  
Size: 30.5 x 30.5 cm  
Code: 4556 0139 - EAN: 3475710099434

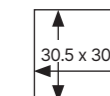



## TECHNICAL CHARACTERISTICS

			DESIGN	PRIME
<b>DESCRIPTION</b>				
Total thickness	EN ISO 24346	mm	1.50	1.30
Thickness of wearlayer	EN ISO 24340	mm	0.08	0.08
Weight: Mass per unit area	EN ISO 23997	g/sqm	2550	2190
Size	EN ISO 24342	cm	tiles: 30.5 x 30.5	tiles: 30.5 x 30.5
Number of planks / tiles and sqm per box	-	tiles	11 tiles / 1 sqm	11 tiles / 1 sqm

<b>CLASSIFICATION</b>				
Norm / Product specification	-	ISO 10582	ISO 10582	ISO 10582
European classification	EN ISO 10874	class	22	22
Fire rating - Classification	EN 13501-1	class	Bfl S1	Bfl S1
Static electrical propretary	EN 1815	-	< 2 kV	< 2 kV
Slip resistance wet: ramp test with oil	DIN 51130	class	R9 / R10	R9 / R10

<b>PERFORMANCE</b>				
Wear group	EN 649	group	T	T
Dimensional stability after exposure to heat	EN ISO 23999	%	< 0.40	< 0.40
Residual Indentation	EN ISO 24343-1	mm	0.04	0.04
Impact sound insulation	EN ISO 717-2	dB	3	3
Room impact noise	NF S 31074	class	C	C
Thermal conductivity	EN ISO 10456	W(m.k)	0.25	0.25
Colour fastness	EN 20 105 - B02	degree	≥ 6	≥ 6
Garantee for residential use	-	year	7	3

<b>ENVIRONMENT / INDOOR AIR QUALITY</b>				
TVOC after 28 days	ISO 16000-6	µg/m³	< 100	< 100
VOC rating (French norm)	-	-	A+	A+

<b>CE MARKING</b>		
	EN 14041	

Areas of use: domestic use

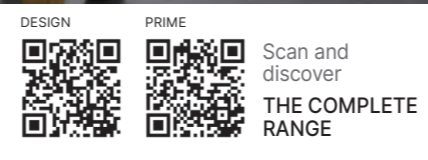

- HEALTH**
- Formaldehyde-free
  - Lead-free, no heavy metals
  - Solvent-free
  - No harmful plasticizer
  - Low VOC emission



TVOC < 100 µg/m³ after 28 days

- ENVIRONMENT**
- ISO 14001
  - Soapy water cleaning

## LAYING

### Installation by subfloor type

#### SMOOTH

Smooth cement that is clean and dry, seamless tiles, liquid screed = can be installed directly

#### UNEVEN

##### Cement, floorboards, tiles

- Securing of loose/exposed parts
- Resurfacing required (wood fibres)
- Sanding

#### SOFT and LOOSE LAY

##### Carpet, vinyl, linoleum, laminate

- Removal of old subfloor and underlayer
- Resurfacing
- Sanding

#### IMPOSSIBLE CASES

Heated floor if > 28°C and/or reversible, oriented strand board (OSB), verandas, cracked floors, humidity buildup

#### TIP

For better adherence, apply Gerflor primer after the subfloor has been sanded, cleaned and vacuumed, before installing the tiles or planks

#### STEP-BY-STEP

- 1- You will need a utility knife, ruler and tape measure
- 2- Start at the centre of the piece
- 3- Follow the instructions on the back
- 4- Remove protective covering
- 5- Position the piece and press down

#### TO REPLACE A TILE OR PLANK

- With a utility knife, pierce the tile or plank several times
- Heat it with a blow dryer to soften it
- Remove and replace it



## HOW TO CARE FOR YOUR GERFLOR FLOOR

### Safety tips

- Use plastic coasters or felt pads under the feet of furniture and other heavy objects.
- Protect from sources of heat and spills.

### Cleaning

**Regular cleaning:** use a vacuum and a damp mop with a standard, no-rinse detergent solution.

Gerflor recommends using its Power Cleaner for routine cleaning.

**Deep cleaning (every 6-12 months):** to make your floor shine like new again, use a restorative product.

Gerflor recommends using its Renovator Polish to protect and enhance the look of your floor.

It leaves a matte finish and brightens up colours.

**Stubborn stains:** use diluted bleach, white spirit, alcohol or lemon juice.

- Stains such as tomato sauce, mustard, beet juice, blood, ink and iodine: use diluted bleach, allowing it to sit for several minutes and then rinsing thoroughly.
- Rust stains: clean with fabric rust remover and rinse thoroughly.
- Marker, pen, grease and glue stains: rub gently with a cloth moistened with white spirit, and rinse thoroughly.

**Products to avoid:** acetone, chlorinated solvents such as trichlorethylene, wax, glaze.

# LVT NUMERICAL INDEX

COLOR CODE	DESIGN COLOR	TYPE	SIZE mm	RANGE	PAGE
60530829	AUTHENTIC BLOND	PLANK	212 x 1238,8	SENSO PREMIUM CLIC	19
60530828	AUTHENTIC NATURE	PLANK	212 x 1238,8	SENSO PREMIUM CLIC	20
60530728	CLEVELAND DARK	PLANK	212 x 1238,8	SENSO PREMIUM CLIC	20
60530837	COLUMBIA	PLANK	212 x 1238,8	SENSO PREMIUM CLIC	19
60530953	COLUMBIA TAUPE	PLANK	212 x 1238,8	SENSO PREMIUM CLIC	20
60531298	GREENLAND GREY	PLANK	212 x 1238,8	SENSO PREMIUM CLIC	19
60531299	GREENLAND LIGHT	PLANK	212 x 1238,8	SENSO PREMIUM CLIC	19
60521213	KARIBA BLOND	PLANK	239,6 x 1460,8	SENSO PREMIUM CLIC	22
60521195	KARIBA DARK	PLANK	239,6 x 1460,8	SENSO PREMIUM CLIC	22
60521196	KARIBA TAUPE	PLANK	239,6 x 1460,8	SENSO PREMIUM CLIC	22
60530309	KOLA	PLANK	212 x 1238,8	SENSO PREMIUM CLIC	19
60530511	PECAN	PLANK	212 x 1238,8	SENSO PREMIUM CLIC	19
60531207	PORTREE LIGHT	PLANK	212 x 1238,8	SENSO PREMIUM CLIC	20
60530286	SUNNY WHITE	PLANK	212 x 1238,8	SENSO PREMIUM CLIC	19
60510938	GOTHA CLEAR	TILE	388,8 x 728,7	SENSO PREMIUM CLIC	23
60510819	INDUSTRY	TILE	388,8 x 728,7	SENSO PREMIUM CLIC	23
60510826	MANHATTAN CLEAR	TILE	388,8 x 728,7	SENSO PREMIUM CLIC	23
60511205	SHALE BEIGE	TILE	388,8 x 728,7	SENSO PREMIUM CLIC	23
60511297	SHALE BLACK	TILE	388,8 x 728,7	SENSO PREMIUM CLIC	23
60511184	VILLA BEIGE	TILE	388,8 x 728,7	SENSO PREMIUM CLIC	23
60260954	COLUMBIA PEARL	PLANK	214 x 1239	SENSO CLIC 30	28
60260286	COTON OAK	PLANK	214 x 1239	SENSO CLIC 30	28
60260955	LORD HONEY	PLANK	214 x 1239	SENSO CLIC 30	28
60261248	MAKONDE	PLANK	214 x 1239	SENSO CLIC 30	28
60260511	PECAN	PLANK	214 x 1239	SENSO CLIC 30	28
60261300	PECAN LIGHT	PLANK	214 x 1239	SENSO CLIC 30	28
60260950	PECAN NATURE	PLANK	214 x 1239	SENSO CLIC 30	28
60261028	SIMBA NATURE	PLANK	214 x 1239	SENSO CLIC 30	28
60261174	TACANA BLOND	PLANK	214 x 1239	SENSO CLIC 30	28
60261173	TACANA GREY	PLANK	214 x 1239	SENSO CLIC 30	28
60271247	KANDY CLEAR	TILE	391 x 729	SENSO CLIC 30	31
60271246	KANDY GREY	TILE	391 x 729	SENSO CLIC 30	31
60270890	PEPPER LIGHT	TILE	391 x 729	SENSO CLIC 30	31
60270889	PEPPER TAUPE	TILE	391 x 729	SENSO CLIC 30	31
60271182	PETRA BEIGE	TILE	391 x 729	SENSO CLIC 30	31
60271183	PETRA BLACK	TILE	391 x 729	SENSO CLIC 30	31
36681093	CASHEW CLEAR	PLANK	177 x 1210	SENSO 20 LOCK	36
36681091	DEW BEIGE	PLANK	177 x 1210	SENSO 20 LOCK	36
36681096	LUMBER FAUVE	PLANK	177 x 1210	SENSO 20 LOCK	36
36681097	LUMBER GREY	PLANK	177 x 1210	SENSO 20 LOCK	36
36681095	LUMBER TAUPE	PLANK	177 x 1210	SENSO 20 LOCK	36
36671119	BRICKELL DARK	TILE	298 x 602	SENSO 20 LOCK	36
36671099	BRICKELL GREY	TILE	298 x 602	SENSO 20 LOCK	36
36671090	TUSCAN	TILE	298 x 602	SENSO 20 LOCK	36
36170035	HELLA WHITE	PLANK	184 x 1219	SENSO EASY PREMIUM	42

COLOR CODE	DESIGN COLOR	TYPE	SIZE mm	RANGE	PAGE
36171027	LORD LIGHT	PLANK	184 x 1219	SENSO EASY PREMIUM	42
36170385	PUZZLE	PLANK	184 x 1219	SENSO EASY PREMIUM	42
36170506	ROSEBUD PEARL	PLANK	184 x 1219	SENSO EASY PREMIUM	42
36170888	SIMBA GREY	PLANK	184 x 1219	SENSO EASY PREMIUM	42
36181034	CORDOBA BLACK	TILE	610 x 610	SENSO EASY PREMIUM	43
36181033	CORDOBA IVORY	TILE	610 x 610	SENSO EASY PREMIUM	43
36160780	FLAGSTONE DARK	TILE	305 x 610	SENSO EASY PREMIUM	43
36160938	GOTHA CLEAR	TILE	305 x 610	SENSO EASY PREMIUM	43
36180917	PROVENCE BLUE	TILE	610 x 610	SENSO EASY PREMIUM	43
36181032	PROVENCE IVORY	TILE	610 x 610	SENSO EASY PREMIUM	43
36160702	WALLSTREET LIGHT	TILE	305 x 610	SENSO EASY PREMIUM	43
35790910	BALADE GREY	PLANK	1219 x 184	SENSO SELF ADHESIVE PREMIUM	49
35790909	BALADE HONEY	PLANK	1219 x 184	SENSO SELF ADHESIVE PREMIUM	49
35790912	BALADE LIGHT	PLANK	1219 x 184	SENSO SELF ADHESIVE PREMIUM	49
35791303	ALTA SKIN	PLANK	1219 x 184	SENSO SELF ADHESIVE PREMIUM	49
35791302	ALTA CLEAR	PLANK	1219 x 184	SENSO SELF ADHESIVE PREMIUM	49
35790287	SIMBA	PLANK	1219 x 184	SENSO SELF ADHESIVE PREMIUM	49
35781034	CORDOBA BLACK	TILE	610 x 610	SENSO SELF ADHESIVE PREMIUM	49
35781033	CORDOBA IVORY	TILE	610 x 610	SENSO SELF ADHESIVE PREMIUM	49
35780890	PEPPER LIGHT	TILE	610 x 610	SENSO SELF ADHESIVE PREMIUM	49
35780889	PEPPER TAUPE	TILE	610 x 610	SENSO SELF ADHESIVE PREMIUM	49
35780920	PROVENCE GOLD	TILE	610 x 610	SENSO SELF ADHESIVE PREMIUM	49
35780919	PROVENCE GREY	TILE	610 x 610	SENSO SELF ADHESIVE PREMIUM	49
33250309	KOLA	PLANK	914 x 152	SENSO RUSTIC	55
33270306	MUSCADE	PLANK	914 x 152	SENSO RUSTIC	55
33270311	NOISETTE	PLANK	914 x 152	SENSO RUSTIC	55
33270511	PECAN	PLANK	914 x 152	SENSO RUSTIC	55
33250394	WHITE PECAN	PLANK	914 x 152	SENSO RUSTIC	55
32800347	COLUMBIA	PLANK	914 x 152	SENSO NATURAL	57
32800019	MERBAU EXOTIC	PLANK	914 x 152	SENSO NATURAL	57
32800018	NOYER NATUREL	PLANK	914 x 152	SENSO NATURAL	57
32800996	SUNNY LIGHT	PLANK	914 x 152	SENSO NATURAL	57
33740397	NIGHT SLATE	TILE	609 x 305	SENSO NATURAL	57
33740201	TRAVERTIN	TILE	609 x 305	SENSO NATURAL	57
33260301	CERUSE BLANC	PLANK	914 x 152	SENSO URBAN	58
33750917	PROVENCE BLUE	TILE	609 x 305	SENSO URBAN	58
33750702	WALLSTREET LIGHT	TILE	609 x 305	SENSO URBAN	58
32370221	BLACK TILE	TILE	305 x 305	DESIGN	63
32370220	SLATE ANTHRACITE	TILE	305 x 305	DESIGN	63
32370632	SQUARE MEDIUM	TILE	305 x 305	DESIGN	63
32370224	WHITE TILE	TILE	305 x 305	DESIGN	63
45560130	GRANITE GREY	TILE	305 x 305	PRIME	63
45560135	MARBLE BEIGE	TILE	305 x 305	PRIME	63
45560139	WOOD CLEAR	TILE	305 x 305	PRIME	63

# COMMUNICATION TOOLS



**ASIA:** Gerflor Asia  
Tel: +852 9222 6355 - Fax: +852 3006 1449  
e-mail: gerflorasia@gerflor.com

**AUSTRALIA/NEW ZEALAND:** Gerflor Australasia Pty. Ltd  
Australia Tel: +61 1 800 060 785  
New Zealand Tel: + 64 0 800 630 119  
e-mail: gerflor@gerflor.com.au

**AUSTRIA/SWITZERLAND:** Gerflor GmbH  
Tel: +43 (0)72 29/70 800-0 - Fax: +43 (0)72 29/70 800-218  
e-mail: austria@gerflor.com - switzerland@gerflor.com

**BELGIUM/LUXEMBURG:** Gerflor Benelux  
Tel: +32 (0)3 766 42 82 - Fax: +32 (0)3 766 29 14  
e-mail: gerflorbe@gerflor.com

**CANADA:** Gerflor International  
Tel: +1 438 333 0752 - Fax: +1 438 380 5425  
e-mail: gerflorcanada@gerflor.com

**CHINA:** Gerflor floorings (China) Co. Ltd.  
Tel: +86 21 6357 8818 - Fax: +86 21 6357 8998  
e-mail: gerflorchina@gerflor.com

**CZECH REPUBLIC & SLOVAKIA:** Gerflor CZ s.r.o.  
Tel: +420 725 815 902

**FINLAND:** Gerflor Oy  
Tel: +358 (0) 10 6 17 5150 - Fax: +358 (0) 10 617 5152  
e-mail: info@gerflor.fi

**FRANCE:** Gerflor  
Tel: 00 33 4 75 50 68 68 - Fax: 00 33 4 75 50 69 95  
e-mail: serviceconso@gerflor.com

**GERMANY:** Gerflor Mipolam GmbH  
Tel: +49 (0)22 41-25 30-0  
e-mail: gerflormipolam@gerflor.com

**IRELAND:** Gerflor Ltd  
Tel: +353 (0) 42 966 1431 - Fax: +353 (0) 42 966 1759  
e-mail: gerfloriri@gerflor.com

**ITALY:** Gerflor S.p.A.  
Tel: +39 02 90 40 10 - Fax: +39 02 90 42 74 84  
e-mail: gerfloritalia@gerflor.com

**LATIN AMERICA (Brazil):** Gerflor América Latina  
Tel: +55 11 38 48 20 20  
e-mail: gerflor@gerflor.com.br

**MIDDLE EAST:** Gerflor Middle East  
Tel: +966 3 847 1779 - Fax: +966 3 847 1781  
e-mail: info@gerflorme.com

**NETHERLANDS:** Gerflor Benelux  
Tel: +31 (0)40 266 17 00 - Fax: +31 (0)40 257 46 89  
e-mail: gerflornl@gerflor.com

**OTHER COUNTRIES:** Gerflor International  
Tel: +33 (0)4 74 05 40 00 - Fax: +33 (0)4 74 05 03 13  
e-mail: gerflorcontract@gerflor.com

**POLAND:** Gerflor Polska Sp z o.o.  
Tel: + 48 61 823 34 01 - Fax: + 48 61 823 34 33  
e-mail: info@gerflor.pl

**PORTUGAL:** Gerflor Iberia, SA  
Tel: +351 21 843 95 49 - Fax: +351 21 846 55 44  
e-mail: gerflorportugal@gerflor.com

**RUSSIA:** Gerflor zao  
Tel./Fax: + 7 495 785 23 71  
e-mail: gerflorussia@gerflor.ru

**SCANDINAVIA:** Gerflor Scandinavia a.s.  
Tel: + 47 64 95 60 70 - Fax: + 47 64 95 60 80  
e-mail: gerflorscand@gerflor.no

**SPAIN:** Gerflor Iberia, SA  
Tel: +34 91 653 50 11 - Fax: +34 91 653 25 85  
e-mail: gerfloriberia@gerflor.com

**UNITED KINGDOM:** Gerflor Ltd  
Sample service: Contractuk@gerflor.com  
Office Tel: + 44 (0) 1926 622 600 - Fax: + 44 (0) 1926 401 647

**USA:** Gerflor USA  
Tel: 877 GERFLOR (437 3567) - Fax: 847 394 3753  
e-mail: info@gerflorusa.com



# FLOOR FOR THE HOME 2022 COLLECTION

TILES & PLANKS COLLECTION

## We care / we act Our Commitments for a Sustainable future



**CARBON FOOTPRINT\***

-20 % kg  
CO<sub>2</sub> equivalent/m<sup>2</sup>  
between 2020 and 2025



**BIOSOURCED CONTENT\*\*\***  
10 % by 2025



**RECYCLED CONTENT**  
30 % by 2025



**ADHESIVE FREE\*\***  
35 % by 2025



**ANNUAL VOLUME RECYCLED**  
60 000 t by 2025

# Gerflor®

\* Scopes 1 and 2 defined in the GHG protocol \*\*\* % of activity with biosourced materials \*\* % of activity - adhesive free solution