

NEW LINEA RANGE

WALL PROTECTIONS AND HANDRAILS

[gerflor.com](https://www.gerflor.com)



Gerflor[®]
theflooringgroup

The comprehensive, harmonious and effective solution for wall protection...



Design
modern
& uncluttered



Ergonomics
at the top and
recognised by experts

LINEA



Performance
& impact resistance
everywhere



Many options
endless
combinations
and finishes

Priority to...

building protection

- Impact resistance
- Fire-rating Bs2d0
- Building durability with reduced maintenance costs

hygiene

- 100% antibacterial (reports by Nosoco.tech)
- 100% decontaminable (tests by Anios and Institut Pasteur)

environment

- Exemplary composition (no heavy metals, very low VOC emissions)
- 100% recyclable
- Reduced environmental impact during installation and in use

An aesthetic, **unique and innovative** line consisting of three elements



corner protector

handrail

protection rail

LINEA' TOUCH

handrail



A handrail with a unique design throughout the building, whatever the level of impact resistance required.

A sleek and modern line with stand-out design and approved ergonomics.



Applications

- Developed with the help of architects and designers, the Linea'Touch handrail combines design, ergonomics and extreme impact resistance.
- Its exclusive trilobed shape validated by ergonomists provides an excellent grip while protecting the walls effectively and discreetly.
- Thanks to its large choice of accessories and colours for endless combinations, Linea'Touch is also available in a reinforced version. It offers an unity of design throughout the building, whatever the level of protection required.
- Linea'Touch can be used in all public areas, delivering aesthetic harmony from light to heavy traffic areas: hospitals, clinics, retirement homes, hotels, communal areas, offices.
- It can be bent and provides various technical solutions for continuity in staircases and in front of service ducts. It is fitted with bactericidal joints.

Description

- Linea'Touch and Linea'Touch+ (reinforced version) trilobed handrail:
 - > Linea'Touch PVC-sheathed : antibacterial smooth and Bs2d0 fire-rated PVC, solid colour, on continuous aluminium section Bactericidal joint
 - > Linea'Touch Decowood: wood effect PVC on continuous aluminium section. Bactericidal joint
 - > Linea'Touch Anodised: satin silver anodised aluminium. Bactericidal joint
- Length: 4 m
- Cross section: height 42 mm x width 40 mm
- Overall Projection: 80 mm
- Stand-off from wall: 40 mm
- Fixing components: refined or reinforced aluminium self-locking brackets, satin silver anodised effect, screwed to the wall every 1.20 m (0.80 m centres in heavy traffic areas and on light partitions like plasterboard.)
- Colours:
 - > Linea'Touch PVC-sheathed: 31 standard
 - > Linea'Touch Decowood: 7 wood effect
 - > Linea'Touch Anodised: 1 standard

Specifications can be downloaded
from our website
www.gerflor.com

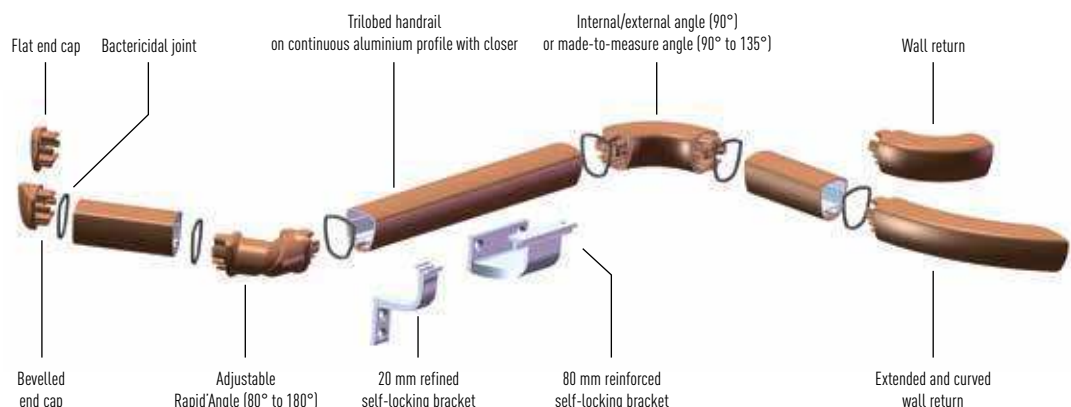
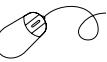

LINEA'TOUCH AND LINEA'TOUCH+

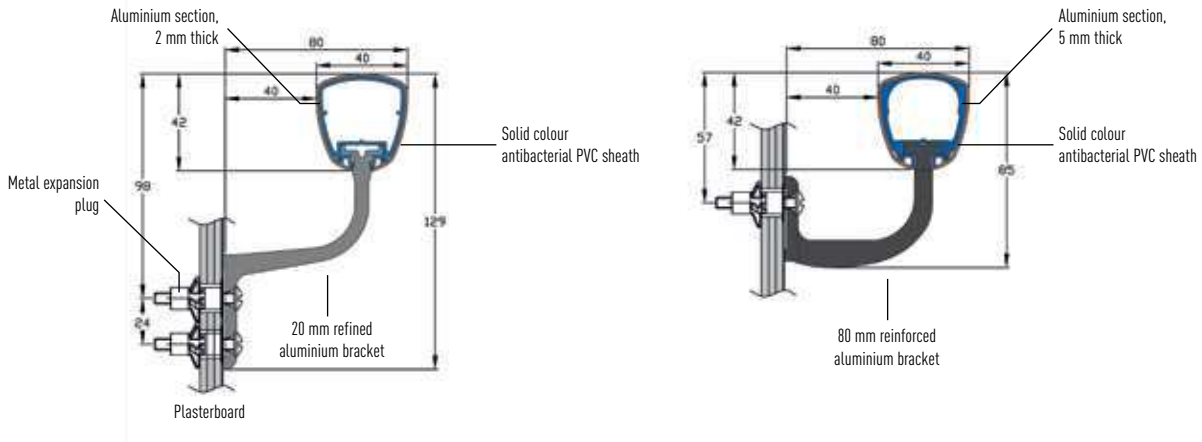

Improved ergonomics



A new handrail shape, created by the desire to combine ergonomics, design and efficiency.

- Anti-rotation trilobed shape > improved grip for stability in case of losing balance
- Larger contact surface > improved support
- Axial position of the bracket > improved guiding

Hygiene

A design delivering maximum hygiene:

- no roughness / all elements easy to clean
- bactericidal joint between accessories and the profile

Benefits

- Effective protection from impact, unique design throughout the building
- Exclusive ergonomics
- Complies with disabled access rules (DGHUC 2007-53 of 30/11/07)

Impact resistance

In the reinforced version, unrivalled impact resistance of 110 joules*, corresponding to an impact exceeding 320 kg at 3 km/h, for robust protection from hospital beds, food trolleys, emergency stretchers, laundry carts.

*Impact resistance tests carried out on the Linea range by the GINGER CEBTP laboratory

Choose...

1 your impact resistance level

Light to moderate traffic
LINEA' TOUCH

Refined aluminium profile and bracket



Heavy traffic
LINEA' TOUCH+

Reinforced profile and reinforced aluminium bracket



2 your profile finish

● PVC-sheathed*



31 colours

● Wood effect

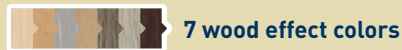

7 wood effect colors

● Silver anodised aluminium



*PVC is strongly recommended in heavy traffic areas

3 your accessories

● End caps

Flat

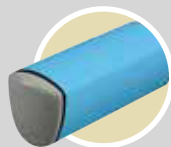

Bevelled

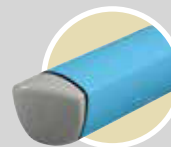

● End pieces

Wall return



Extended and curved wall return



● Angles

Internal/external (90°) or made-to-measure (90° to 135°)

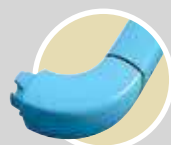

Adjustable Rapid'Angle (80° to 180°)



LINEA' PUNCH

protection rail



A modern and discreet protection rail that well-blends with the new Linea'Touch handrail.

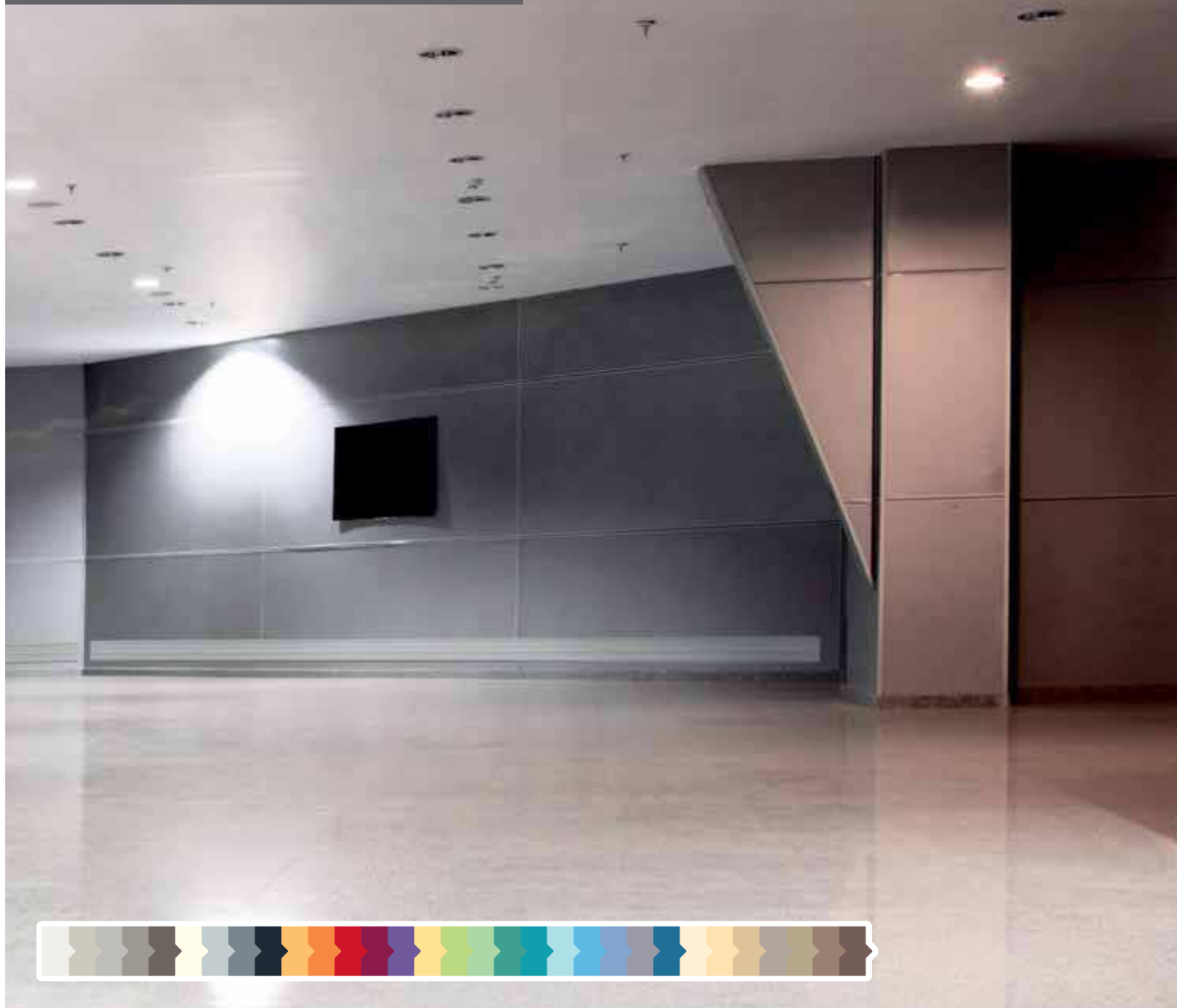

Applications

- The Linea'Punch protection rail is the perfect alliance between impact resistance and design. Its uncluttered line helps it merge with the décor, and matches perfectly the Linea'Touch handrail for an aesthetic and high-performance solution throughout the building.
- Its narrow bevelled end pieces minimise projection and reduce the distance to door frames, and the wall-hugging profile makes for easy cleaning and maximum hygiene. It is easy and quick to install, thanks to its double clipping.
- It provides effective and discreet protection for walls exposed to heavy trolley traffic in corridors, access areas and storage rooms (hospitals, clinics, retirement homes, labs, clean rooms, hotels, restaurants, schools).

Description

- Model: Linea'Punch protection rail
- Height: 180 mm
- Thickness: 25 mm
- Length: 4 m
- Material: 2.5 mm thick PVC, antibacterial and Bs2d0 fire-rated, solid colour
- Surface finish: smooth with central boss
- Fixing components: aluminium brackets (optional: continuous aluminium rail)
- Colours: 31 standard

Specifications can be downloaded from our website www.gerflor.com

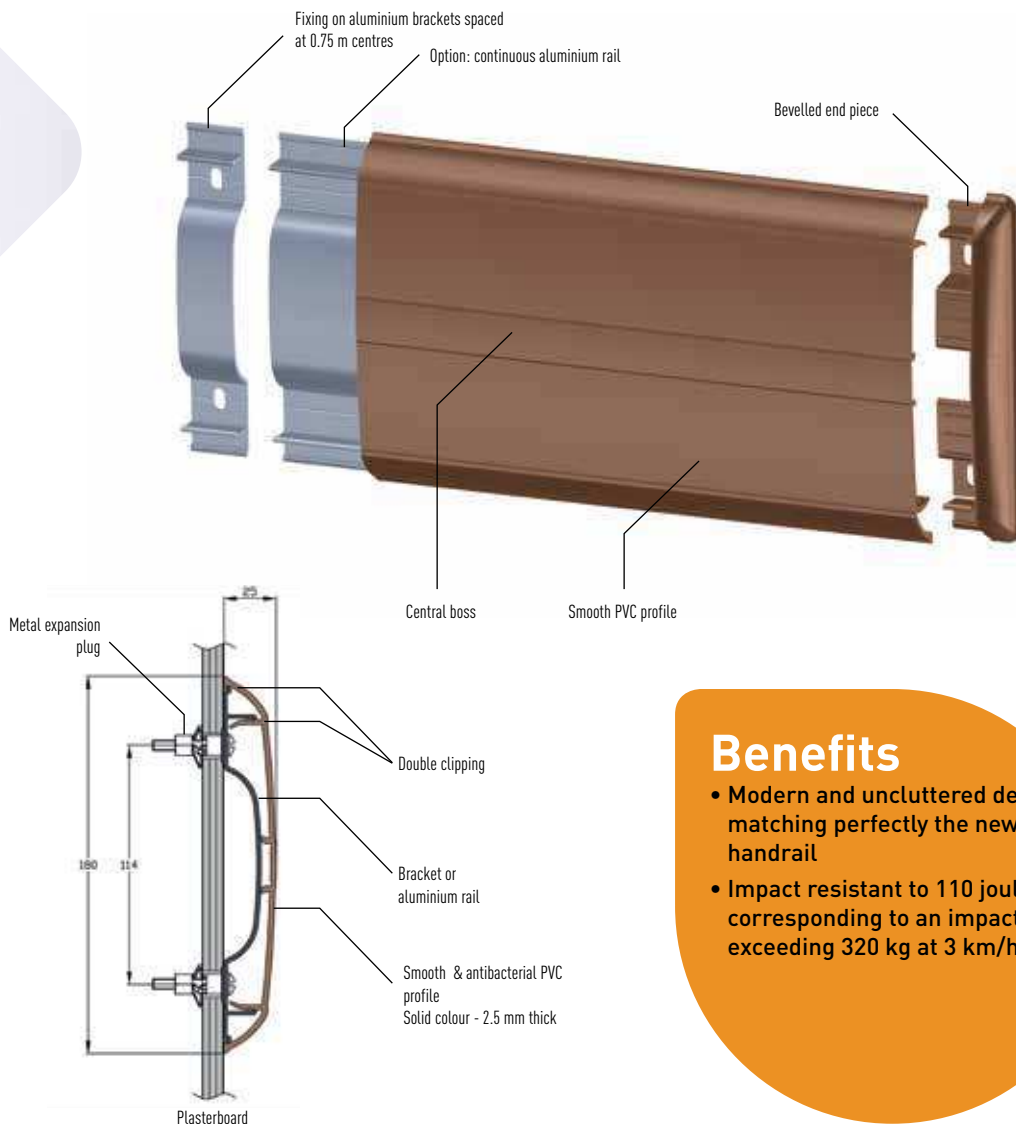
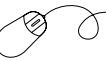

Benefits

- Modern and uncluttered design, matching perfectly the new handrail
- Impact resistant to 110 joules* corresponding to an impact exceeding 320 kg at 3 km/h

LINEA' FLEX corner protector



An aesthetic and impact-resistant corner protector that adjusts to all angles.



Applications

- The Linea'Flex corner protector is the product of advanced technical expertise, combining impact resistance, flexibility and discretion, and blending perfectly with the Linea range.
- It provides effective protection for all angles from 80° to 150° thanks to its flexible central part mounted on two dampers for added resistance.
- Thanks to its variable angle endcap it fits to any height with maximum hygiene.
- Installation is quick and easy with two strips of double-sided adhesive tape.
- It blends discreetly into corridors and rooms that are exposed to repeated impacts in hospitals, clinics, retirement homes, schools, hotels, restaurants, offices and stores.

Description

- Model: Linea'Flex flexible adhesive corner protector
- Angle: from 80° to 150°
- Wing width: 53 mm
- Thickness: cross-section up to 3 mm
- Length: 1.30 m, 2.00 m or 4.00 m
- Material: antibacterial and Bs2d0 fire-rated PVC, solid colour
- Surface finish: smooth
- Fixing: adhesive foam strips reinforced with Gerflor universal mastic glue
- Colours: 31 standard

Specifications can be downloaded from our website www.gerflor.com

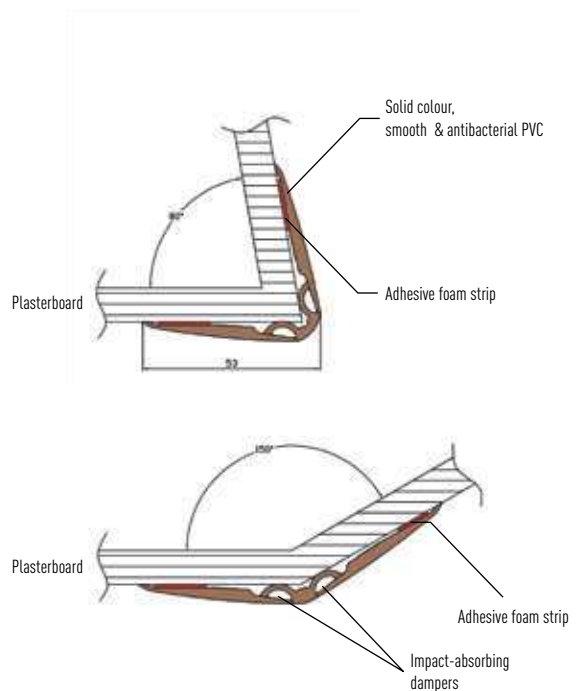
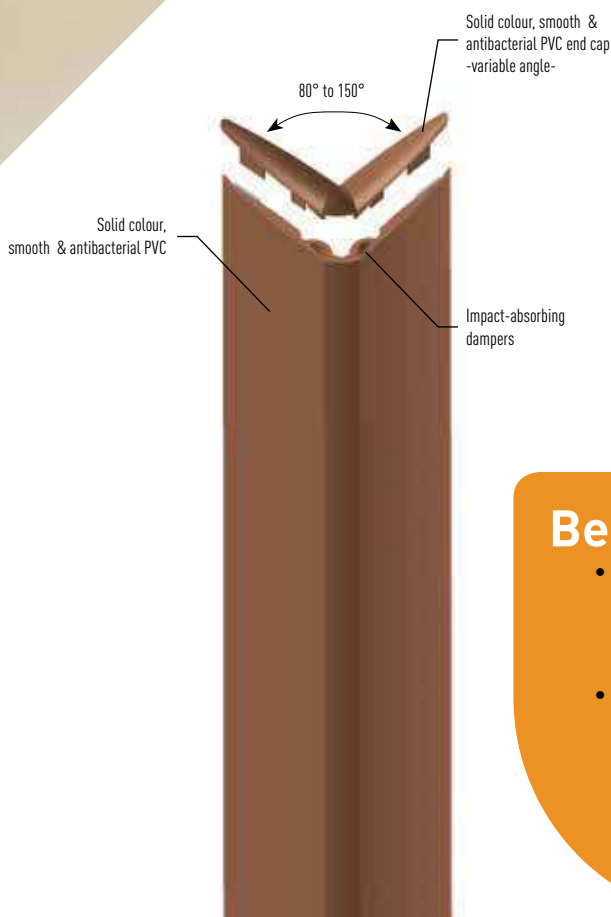
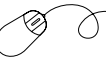

Benefits

- Universal (height and angle) thanks to the adjustable angle and flexible edge.
- Impact-resistant to 110 joules* corresponding to an impact exceeding 320 kg at 3 km/h.
- Discreet
- Low wrenching thanks to the progressive profile.
- Protects buildings and people with two impact-absorbing dampers.

SPM WALL PROTECTIONS AND HANDRAILS

The right solutions for all situations



∞ A wide choice of colours
to meet all your desires

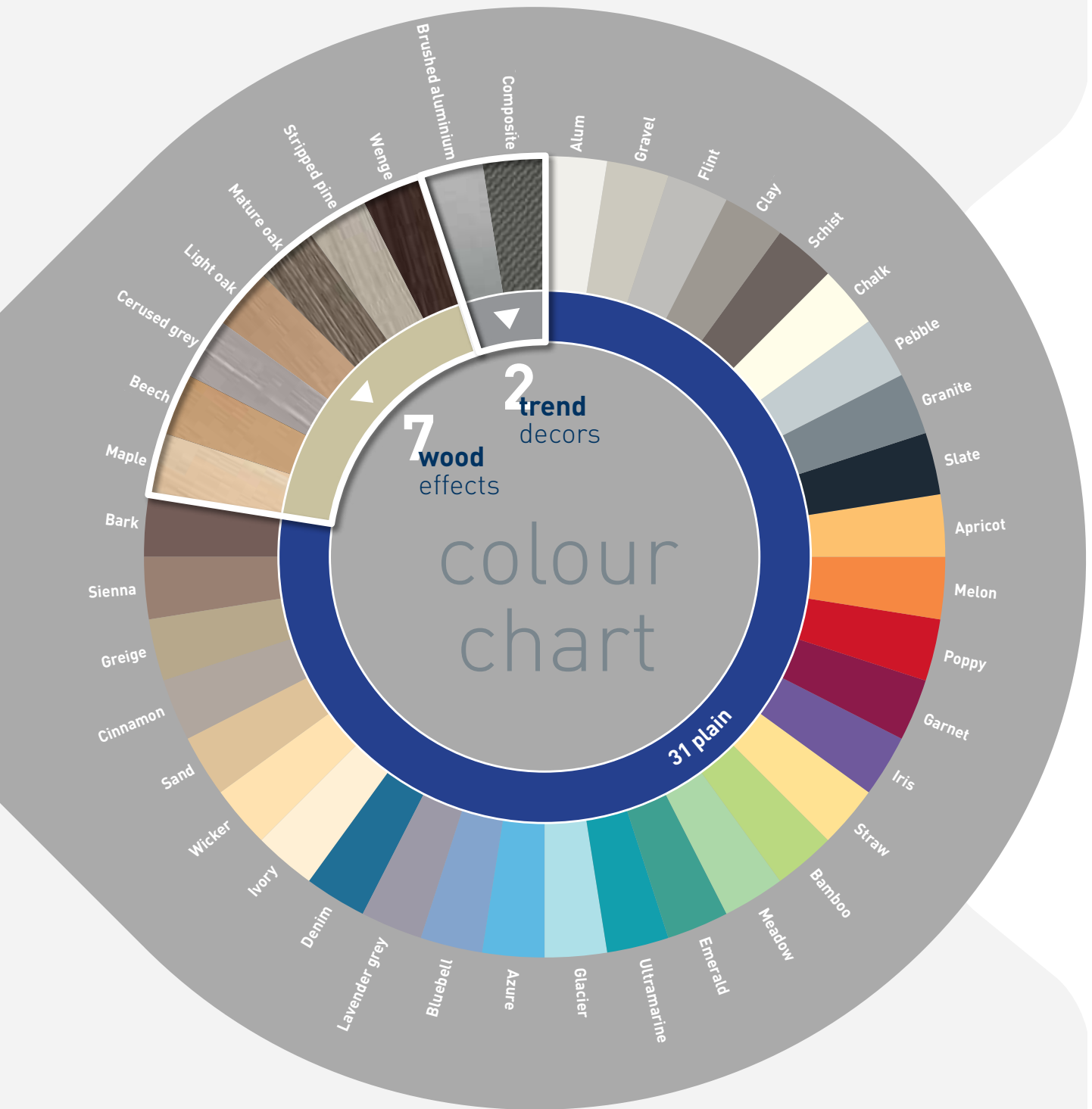

SUMMARY

HANDRAILS, PROTECTION RAILS, CORNER PROTECTORS AND PANELS **FROM SPM**

NEW

Handrails



Linea'Touch

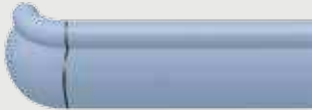

Performer

Wall protection



Linea'Punch

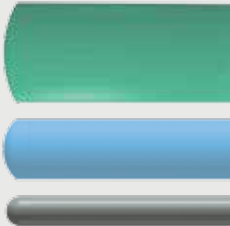

Impact

Corner protectors



Linea'Flex



Cornea



Corneaflex

Panels



Decochoc



Decoclean



Decotrend/Decowood

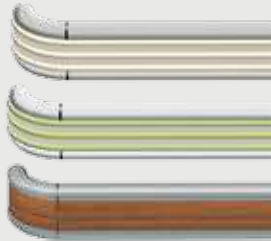

Starline



Escort

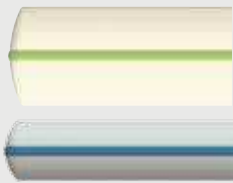

Alinea



Contact

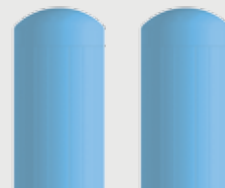

Bedkit



Capcorn



Protecta 2



Profila



Profil'inox

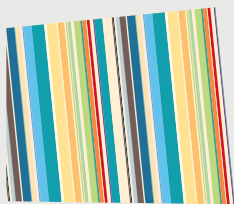

Decoprint
customised printing

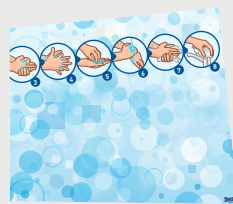

Decocare



Decokid

gerflor.com

ARCHITECTURE
DECORATION
SPORT
TECHNOSPECIFIC

ASIA: Gerflor Asia

Tel: +852 9222 6355 - Fax: +852 3006 1449
e-mail: gerflorasiam@gerflor.com

AUSTRALIA/NEW ZEALAND: Gerflor Australasia Pty. Ltd

Australia Tel: 1 800 060 785 - New Zealand Tel: 0 800 630 119
e-mail: gerflor@gerflor.com.au

AUSTRIA/SWITZER LAND: Gerflor GmbH

Tel: +43 (0)7229/70800-0 - Fax: +43 (0)7229/70800-218
e-mail: austria@gerflor.com - switzerland@gerflor.com

BELGIUM/LUXEMBURG: Gerflor Benelux

Tel: +32 (0)3 766 42 82 - Fax: +32 (0)3 766 29 14
e-mail: gerflorbelgium@gerflor.com

CANADA: Gerflor International

Tel: +1 450 538 9828 - Fax: +1 450 538 9827
e-mail: gerflorcanada@gerflor.com

CHINA: Gerflor Floorings (CHINA) Co. Ltd.

Tel: +86 21 6357 8818 - Fax: +86 21 6357 8998
e-mail: gerflorchina@gerflor.com

FINLAND : Gerflor OY

Tel.: +358 (0) 10 617 5150 - Fax: +358 (0) 10 617 5152
e-mail: info@gerflor.fi

FRANCE: SPM

Customer department: Tel: + 33 (0)5 34 39 41 00 - Fax: +33 (0)5 34 39 41 02
e-mail: service.clientele@spm.fr

GERMANY: Gerflor Mipolam GmbH

Tel: 0 22 41-25 30-0
e-mail: GerflorMipolam@Gerflor.com
Kunden-Service: kundenservice@gerflor.com
Tel: 0 22 41-25 30-131 - Fax: 0 22 41-25 30-100
SAT Service und Anwendungstechnik: Technik@Gerflor.com
Tel: 0 22 41-25 30-555 - Fax: 0 22 41-25 30-550

IRELAND: Gerflor Ltd

Tel: +353 (0) 42 966 1431 - Fax: +353 (0) 42 966 1759
e-mail: gerflorirl@gerflor.com

ITALY: Gerflor S.p.A.

Tel: +39 02 90 78 60 12 r.a. - Fax: +39 02 90 42 74 84
e-mail: gerfloritalia@gerflor.com

LATIN AMERICA (Brazil): Gerflor América Latina

Tel: +55 11 38 48 20 20 - Fax: +55 11 38 48 20 23
e-mail: gerflor@gerflor.com.br

MIDDLE EAST: Gerflor Middle East

Tel: +966 3 847 1779 - Fax: +966 3 847 1781
e-mail: gerflorME@gerflor.com

NETHERLANDS: Gerflor BV

Tel: +31 (0)40 266 17 00 - Fax: +31 (0)40 257 46 89
e-mail: gerflorNL@gerflor.com

OTHER COUNTRIES: Gerflor International

Tel: +33 (0)4 74 05 40 00 - Fax: +33 (0)4 74 05 03 13
e-mail: gerflorcontract@gerflor.com

POLAND: Gerflor Polska Sp z o.o

Tel: + 48 61 823 34 01 - Fax: + 48 61 823 34 33
e-mail: info@gerflor.pl

PORTUGAL: Gerflor Iberia, SA

Tel: +351 21 843 95 49 - Fax: +351 21 846 55 44
e-mail: gerflorportugal@gerflor.com

RUSSIA: Gerflor Moscow Office

Tel: +7 499 783 63 69 / 81 - Fax: +7 499 783 62 52
e-mail: gerflorrus@mspk.east.ru

SCANDINAVIA: Gerflor Scandinavia a.s.

Tel: + 47 64 95 60 70 - Fax: + 47 64 95 60 80
e-mail: gerflorscand@gerflor.no

SPAIN: Gerflor Iberia, SA

Tel: +34 91 653 50 11 - Fax: +34 91 653 25 85
e-mail: gerfloriberia@gerflor.com

UNITED KINGDOM: Gerflor Ltd

Tel: + 44 (0) 1926 622 600 - Fax: + 44 (0) 1926 401 647
e-mail: contractuk@gerflor.com

USA: Gerflor North America

Tel: 877 GERFLOR (437 3567) - Fax: 847 394 3753
e-mail: info@gerflorusa.com



Health
& Safety



ISO 14001



Recycling



LCA
Life Cycle
Analysis

Committed to sustainable development

Gerflor[®]
theflooringgroup