

[305] GLUE-DOWN: FULL-WIDTH STEP AND TACTILE STRIP

Including custom signage on the rounded stair nosing.

Disabled access rules DGUHC 2007-53 of 30 November 2007

Before laying the flooring, it is a good idea to inspect it and to identify any problems with the appearance. If there are visible defects, please notify GERFLOR and wait to hear from them before laying the flooring.

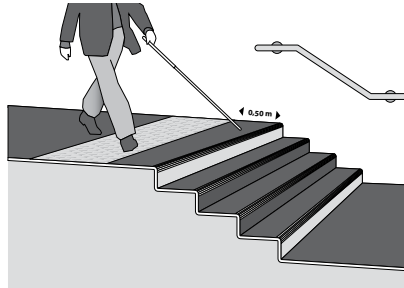
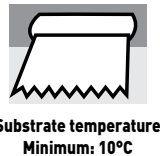
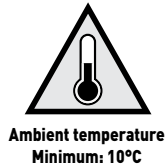

GLUING FULL WIDTH STEPS

Do not use solvent based neoprene adhesive to glue down the steps.
We recommend UZIN WK 222 solvent free neoprene adhesives.
The stair nosing must be rounded off to a curve radius of at least 12 mm.

1. INTRODUCTION

The materials are available in lengths of 100 cm to cover two winders or two straight steps. Two finishes are available for the corner between the tread and the riser (as described in the new technical reports):

- Step clip (clip-on finishing profile).
- Cold welding.

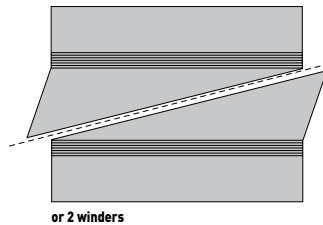
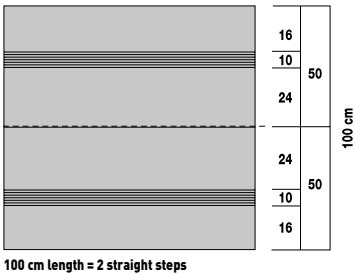

To find out which Gerflor floor coverings can be used with which stair nosings, visit:
www.gerflor.co.uk/solutions-for-professionals/

2. PREPARATION

2.1 - SUBSTRATE

The substrate should be flat, sound, smooth, clean and dry.
The curve radius of the stair nosing must be at least 12 mm.
Carefully level the tread and the riser using a skimming compound that has been described in a technical report. A non-drip, thixotropic compound is recommended for the riser.

2.2 - STAIR NOSINGS

2.2.1 - Protruding stair nosing

Finish with a filler or a profile under the protruding part.

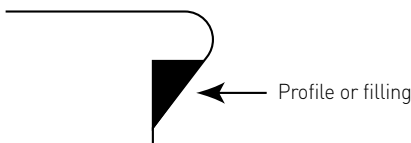

2.2.2 - Stair nosing with sharp corner

Work over the corner several times to round it off to a 12 mm curve radius.

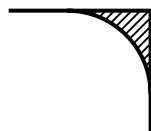

2.3 - PREPARING STAIRS

2.3.1 - Treads and risers

If the substrate is absorbent, apply a primer that is suitable for use with the particular adhesive.

2.3.2 - Back of tread (if finishing clips are used: Ref H 158)

- Glue the base of the clip in the corner between the tread and the riser.

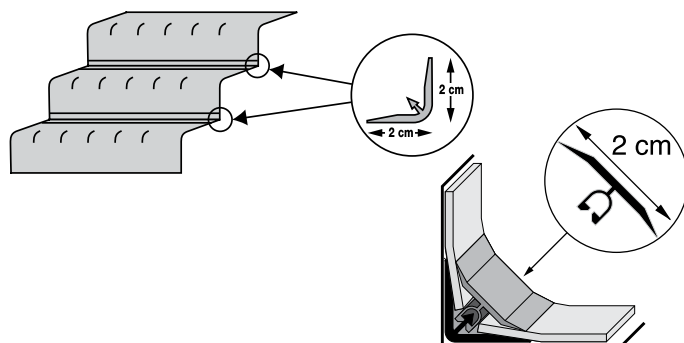

FLOORS IN BUILDINGS

GLUE-DOWN: FULL-WIDTH STEP AND TACTILE STRIP

2.4 - LAYING FULL-WIDTH STEPS

2.4.1 - Marking the stair nosing:

Draw a line along the middle of the stair nosing.

2.4.2 - Prepare the full-width steps

2.4.2.1 - Cutting

- The day before laying, cut the flooring to the stair dimensions lengthwise, plus 5 cm.

2.4.2.2 - Prepare the contrasting risers

Legal requirement:

The first and last step must have a riser at least 10 cm in height, which contrasts visually with the tread.

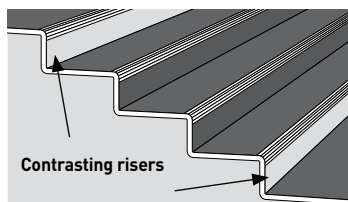

Gerflor supplies two products:

- Welded fitted strips using the same product in a different colour.
- Contrasting adhesive strips (see 5.2).

Welded fitted strips:

Prepare these steps before installing them.

- Before installation, cut the riser to create at least 10 cm to contrast visually with the tread.
- Cut the same shape in the contrasting material, using the cut as a template.
- Hot weld the two floor coverings on the flat before fitting the step.

2.4.2.3 - Mark out the floor covering

Use a pencil to draw a line on the back of the cut floor covering 2/3 of the way into the textured section (see diagram).

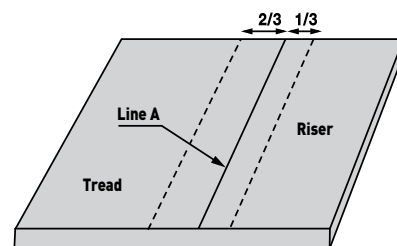

3. LAYING FULL-WIDTH STEPS

3.1 - GLUING

Gerflor does not recommend using solvent based neoprene adhesive unless you have already applied a Helmitin 533 primer. Gerflor recommends aqueous phase neoprene adhesive.

AQUEOUS PHASE NEOPRENE ADHESIVE	SOLVENT BASED NEOPRENE CONTACT ADHESIVE
Uzin WK222 150-200 g/m ² per surface Foam roller supplied with the adhesive	HB/Fuller Helmitin 533 primer Neoprene adhesive 100-150 g/m ² per surface Finely serrated spatula

Refer to the product data sheets.

3.2 - LAYING THE STEPS

- Start laying the flooring at the bottom of the stairs.
- After the specified drying time, roll up the flooring, position it on the stair nosing, then unroll it making sure it is lined up with the marking on the stair nosing.

- Smooth out the material very firmly in the following order:

- the tread texturing, lengthwise;
 - the tread, from the centre to the edges;
 - the rounded part of the texturing, from the riser downwards;
 - the riser itself, from the centre to the edges.
- 5a. Step clip: Cut the floor covering in the tread/riser corners on the base of the clip, leaving 2 mm on each side of the pin.
5b. Cold welding: Cut the floor covering in the tread/riser corners.

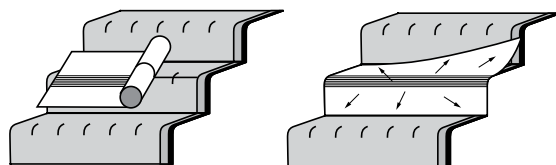

4. JOIN WITH THE LANDING

- The treads of the top steps are cut where the stair nosing texturing starts, to avoid a colour difference with the material laid on the tread.
- The stair nosing and landing floor covering are joined by hot welding with a round cord CR40.

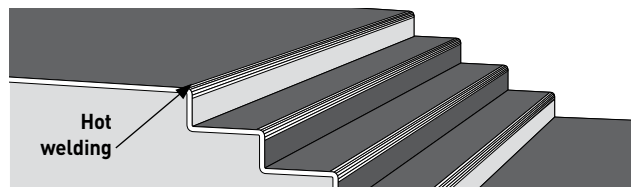

5. FINISHES

5.1 - BACK OF TREAD

5.1.1 - Step clip

- Insert the clip-on profile in the base by pressing down.

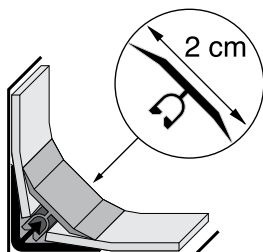

5.1.2 - Cold welding:

- See the diagram opposite.

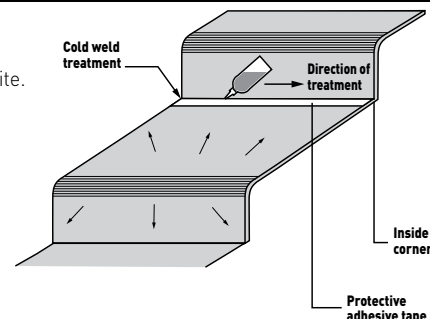

GLUE-DOWN: FULL-WIDTH STEP AND TACTILE STRIP

5.2 - CONTRASTING ADHESIVE STRIP ON THE RISERS

- Clean
- Pull off the protective film
- Apply the adhesive strip at the bottom of the riser
- Cut away the excess material

PRODUCTS	DIMENSIONS	GERFLOR CODE	REFERENCE
ADH. RISER 10CMX10ML	10 cm x 10 m	058L	0001 white
ADH. RISER COUL10CMX10ML		058M	0003 black 0005 yellow

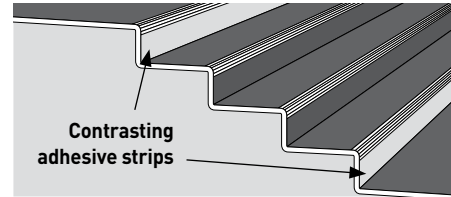

6. FIRST USE

12 to 24 hours after laying depending on the specified gluing method (see the technical report for the adhesive).

7. OTHER STAIRCASE TYPES

- Spiral staircases: create a central passage.
- Metal stairs with riser (rounded nosing).
Strip fully, exposing the metal.

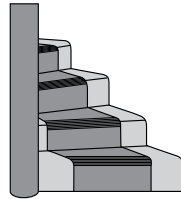

Full-width steps cannot be used in these three cases:

- Staircase with convex or concave steps.
- Staircase with metal stair nosings: if there is a sharp corner or if there is no riser.
- Staircase without risers.

Use a floor covering in rolls or tiles with a fitted stair nosing profile.

8. WARNING STRIPS

Legal requirement:

At the top of the stairs, the floor covering must create a visual and tactile contrast in order to provide a warning at a distance of 0.50 m from the first step.

8.1 - SELF-ADHESIVE TACTILE STRIP:

1. Remove grease if necessary
2. Mark a line 50 cm from the stair nosing
3. Position the self-adhesive tactile strip, remembering the width of the strip - 420 mm

Strip dimensions: 420/1350 mm - 825/420 mm

PRODUCTS	DIMENSIONS	GERFLOR CODE	REFERENCE
TACTILE TILE 420X1350 - 4 UNITS	420 X 1350	058F	0002 grey 0003 black - 0004 orange
TACTILE TILE 825X420 - 6 UNITS	420 x 825	058H	0002 grey 0003 black - 0004 orange

8.2 - SELF-ADHESIVE TACTILE STUDS:

1. Remove grease if necessary
2. Mark a line 50 cm from the stair nosing
3. Position the template
4. Install the studs using the template

Strip dimensions: One kit can create a strip of length 1350 / width 400 mm, or 200 studs.

PRODUCTS	DIMENSIONS	GERFLOR CODE	REFERENCE
TACTILE STUDS 200 UNITS	Diameter 25 x height 5	058K	0002 grey 0003 black - 0004 orange

Gerflor guarantees strips and tactile studs with the following floor coverings: Taralay Matières, Massifs, Taralay Impression, Nera, Mipolam Homogènes and Taradal Confort. To check compatibility with other Gerflor products, please contact our technical department.

8.3 - INLAID TACTILE STRIP:

1. Mark a line 50 cm from the stair nosing.
2. Glue down the warning strip in the same way as the floor covering of the landing.
3. Use scribing to cut the floor covering of the landing around this strip.
4. Bevel, hot weld and cut away the excess.

Dimensions of the inlaid strip: L:1350 / W:400 mm or L:2000 / W: 400 mm

PRODUCTS	DIMENSIONS	GERFLOR CODE	REFERENCE
INLAID TACTILE STRIP 5 UNITS 2.00 x 0.4	2000 x 400 mm	L008	0005 yellow 0007 light grey 0009 dark grey
INLAID TACTILE STRIP 5 UNITS 1.35 x 0.4	1350 x 400 mm	L009	0005 yellow 0007 light grey 0009 dark grey

